



RIGOL

DG800 Pro Series

Function/Arbitrary Waveform Generator

User Guide

Dec. 2023



Guaranty and Declaration

Copyright

© 2023 RIGOL TECHNOLOGIES CO., LTD. All Rights Reserved.

Trademark Information

RIGOL® is the trademark of RIGOL TECHNOLOGIES CO., LTD.

Notices

- RIGOL products are covered by P.R.C. and foreign patents, issued and pending.
- RIGOL reserves the right to modify or change parts of or all the specifications and pricing policies at the company's sole decision.
- Information in this publication replaces all previously released materials.
- Information in this publication is subject to change without notice.
- RIGOL shall not be liable for either incidental or consequential losses in connection with the furnishing, use, or performance of this manual, as well as any information contained.
- Any part of this document is forbidden to be copied, photocopied, or rearranged without prior written approval of RIGOL.

Product Certification

RIGOL guarantees that this product conforms to the national and industrial standards in China as well as the ISO9001:2015 standard and the ISO14001:2015 standard. Other international standard conformance certifications are in progress.

Contact Us

If you have any problem or requirement when using our products or this manual, please contact RIGOL.

E-mail: service@rigol.com

Website: <http://www.rigol.com>

Section	Description	Page
	List of Figures.....	IV
	List of Tables.....	VI
1	Safety Requirement	1
1.1	General Safety Summary	1
1.2	Safety Notices and Symbols	2
1.3	Measurement Category	3
1.4	Ventilation Requirement	4
1.5	Working Environment	4
1.6	Care and Cleaning	5
1.7	Environmental Considerations	6
2	Product Features	7
3	Document Overview	8
4	Quick Start	9
4.1	General Inspection	9
4.2	Appearance and Dimensions	9
4.3	To Prepare for Use	10
4.3.1	To Connect to Power	10
4.3.2	Turn-on Checkout	11
4.3.3	To Set the System Language	12
4.4	Product Overview	12
4.4.1	Front Panel Overview	12
4.4.2	Rear Panel Overview	15
4.4.3	User Interface Overview	18
4.5	Touch Screen Gestures	20
4.5.1	Tap	20
4.5.2	Drag	21
4.6	Parameter Setting Method	21
4.6.1	To Set Parameters with the Front-panel Keys and Knobs	21
4.6.2	To Set Parameters with the Touch Screen	23
4.7	To Use the Built-in Help System	27
4.8	To View the Option Information and Install the Option	27
5	Continuous	29
5.1	To Output Sine Wave	30

5.2	To Output Square Wave	32
5.3	To Output Ramp Wave	34
5.4	To Output Pulse	36
5.5	To Output Noise	38
5.6	To Output Arbitrary Waveforms	40
5.7	To Output Harmonic	44
6	Modulation	48
6.1	Amplitude Modulation (AM)	48
6.2	Frequency Modulation (FM)	50
6.3	Phase Modulation (PM)	52
6.4	Amplitude Shift Keying (ASK)	53
6.5	Frequency Shift Keying (FSK)	55
6.6	Phase Shift Keying (PSK)	56
6.7	Pulse Width Modulation (PWM)	57
6.8	SUM Modulation	59
7	Sweep	61
7.1	Sweep Type	61
7.2	Start Frequency and Stop Frequency	63
7.3	Center Frequency and Frequency Span	63
7.4	Sweep Time	64
7.5	Start/Stop Hold Time	65
7.6	Return Time	65
7.7	Sweep Trigger Source	66
7.8	Mark Frequency	66
8	Burst	68
8.1	Burst Type	69
8.2	Burst Delay	70
8.3	Burst Phase	70
8.4	Burst Period	71
8.5	Burst Trigger Source	71
8.6	Gate Polarity	72
8.7	Idle Level	72
9	Sequence	74
9.1	To Edit Sequence	74
9.2	To Save/Load Sequence	76
9.3	To Set Sequence Parameters	76
10	Frequency Counter	78

10.1 To Enable the Counter	79
10.2 To Set the Counter	79
10.3 Statistical Function	80
11 Channel Copy	82
12 Channel Setup	85
12.1 Sync Signal Setup	85
12.2 Trigger Output Setup	87
12.3 Channel Output Setup	88
13 Coupling Setup	90
14 Align Phase	93
15 Storage Management	94
15.1 To Select the File	94
15.2 To Create New Folder	95
15.3 Cut and Copy	95
15.4 Rename	95
15.5 Delete	95
16 Upgrade	96
17 System Utility Function Setting	97
17.1 I/O Setting	97
17.2 LXI	99
17.3 Basic Settings	99
17.4 About this Instrument	101
17.5 Print Screen	102
17.6 Option	102
17.7 Open Source Acknowledgment	103
17.8 Self-check	103
18 Preset Function	104
19 Remote Control	109
20 Troubleshooting	110
21 Appendix	112
21.1 Appendix A: Options and Accessories	112
21.2 Appendix B: Warranty	112

List of Figures

Figure 4.1 Front View	9
Figure 4.2 Side View	10
Figure 4.3 Connect to Power	11
Figure 4.4 Front Panel	12
Figure 4.5 Rear Panel	15
Figure 4.6 User Interface	18
Figure 4.7 Tap Gesture	20
Figure 4.8 Drag Gesture	21
Figure 4.9 English Input Interface	24
Figure 4.10 Chinese Input Interface	25
Figure 4.11 Numeric Keypad	26
Figure 5.1 Continuous Setting Interface	29
Figure 5.2 Harmonic Setting Interface	45
Figure 5.3 Table Editing Menu	47
Figure 6.1 Modulation Setting Interface	48
Figure 7.1 Sweep Setting Interface	61
Figure 7.2 Linear Sweep	62
Figure 7.3 Logarithmic Sweep	62
Figure 7.4 Step Sweep	63
Figure 8.1 Burst Setting Interface	68
Figure 9.1 Sequence Setting Interface	74
Figure 9.2 Sequence Editing Table	75
Figure 10.1 Counter Menu	78
Figure 10.2 Counter Statistical Interface	81
Figure 12.1 Channel Setup Interface	85
Figure 13.1 "Coupling" Menu	90
Figure 14.1 Before Aligning Phase	93

Figure 14.2 After Aligning Phase	93
Figure 18.1 Preset Menu	104

List of Tables

Table 4.1 Power Adaptor Specifications	11
Table 5.1 Range of Continuous Waveform Frequency	30
Table 5.2 Built-in Waveforms	40
Table 11.1 Dual-channel operation parameters	82
Table 12.1 Sync Signal of Different Output Modes (Positive Polarity)	86
Table 18.1 Factory Settings	105

1 Safety Requirement

1.1 General Safety Summary

Please review the following safety precautions carefully before putting the instrument into operation so as to avoid any personal injury or damage to the instrument and any product connected to it. To prevent potential hazards, please follow the instructions specified in this manual to use the instrument properly.

- **Use the BNC Output Connectors Properly.**

The front-panel and BNC output connectors only allow signal output but unable to support signal input.

- **Use Proper Power Cord.**

Only the exclusive power cord designed for the instrument and authorized for use within the destination country could be used.

- **Observe All Terminal Ratings.**

To avoid fire or shock hazard, observe all ratings and markers on the instrument and check your manual for more information about ratings before connecting the instrument.

- **Use Proper Overvoltage Protection.**

Ensure that no overvoltage (such as that caused by a bolt of lightning) can reach the product. Otherwise, the operator might be exposed to the danger of an electric shock.

- **Do Not Operate Without Covers.**

Do not operate the instrument with covers or panels removed.

- **Do Not Insert Objects into the Air Outlet.**

Do not insert objects into the air outlet, as doing so may cause damage to the instrument.

- **Avoid Circuit or Wire Exposure.**

Do not touch exposed junctions and components when the instrument is powered on.

- **Do Not Operate With Suspected Failures.**

If you suspect that any damage may occur to the instrument, have it inspected by RIGOL authorized personnel before further operations. Any maintenance, adjustment or replacement especially to circuits or accessories must be performed by RIGOL authorized personnel.

- **Provide Adequate Ventilation.**

Inadequate ventilation may cause an increase of temperature in the instrument, which would cause damage to the instrument. So please keep the instrument well ventilated and inspect the air outlet and the fan regularly.

- **Do Not Operate in Wet Conditions.**

To avoid short circuit inside the instrument or electric shock, never operate the instrument in a humid environment.

- **Do Not Operate in an Explosive Atmosphere.**

To avoid personal injuries or damage to the instrument, never operate the instrument in an explosive atmosphere.

- **Keep Instrument Surfaces Clean and Dry.**

To avoid dust or moisture from affecting the performance of the instrument, keep the surfaces of the instrument clean and dry.

- **Prevent Electrostatic Impact.**

Operate the instrument in an electrostatic discharge protective environment to avoid damage induced by static discharges. Always ground both the internal and external conductors of cables to release static before making connections.

- **Use the Battery Properly.**

Do not expose the battery (if available) to high temperature or fire. Keep it out of the reach of children. Improper change of a battery (lithium battery) may cause an explosion. Use the RIGOL specified battery only.

- **Handle with Caution.**

Please handle with care during transportation to avoid damage to keys, knobs, interfaces, and other parts on the panels.

**WARNING**

Equipment meeting Class A requirements may not offer adequate protection to broadcast services within residential environment.

1.2 Safety Notices and Symbols

Safety Notices in this Manual:

**WARNING**

Indicates a potentially hazardous situation or practice which, if not avoided, will result in serious injury or death.

**CAUTION**

Indicates a potentially hazardous situation or practice which, if not avoided, could result in damage to the product or loss of important data.

Safety Notices on the Product:

- **DANGER**
It calls attention to an operation, if not correctly performed, could result in injury or hazard immediately.
- **WARNING**
It calls attention to an operation, if not correctly performed, could result in potential injury or hazard.
- **CAUTION**
It calls attention to an operation, if not correctly performed, could result in damage to the product or other devices connected to the product.

Safety Symbols on the Product:

**Hazardous
Voltage**



Safety Warning



**Protective Earth
Terminal**

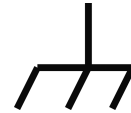

Chassis Ground



Test Ground

1.3 Measurement Category

Measurement Category

This instrument can make measurements in Measurement Category I.

**WARNING**

This instrument can only be used for measurements within its specified measurement categories.

Measurement Category Definitions

- **Measurement category I** is for measurements performed on circuits not directly connected to MAINS. Examples are measurements on circuits not derived from MAINS, and specially protected (internal) MAINS derived circuits. In the latter case, transient stresses are variable. Thus, you must know the transient withstand capability of the equipment.
- **Measurement category II** is for measurements performed on circuits directly connected to low voltage installation. Examples are measurements on household appliances, portable tools and similar equipment.
- **Measurement category III** is for measurements performed in the building installation. Examples are measurements on distribution boards, circuit-breakers, wiring (including cables, bus-bars, junction boxes, switches and socket-outlets) in the fixed installation, and equipment for industrial use and some other

equipment. For example, stationary motors with permanent connection to a fixed installation.

- **Measurement category IV** is for measurements performed at the source of a low-voltage installation. Examples are electricity meters and measurements on primary overcurrent protection devices and ripple control units.

1.4 Ventilation Requirement

This instrument uses a fan to force cooling. Please make sure that the air inlet and outlet areas are free from obstructions and have free air. When using the instrument in a bench-top or rack setting, provide at least 10 cm clearance beside, above and behind the instrument for adequate ventilation.



CAUTION

Inadequate ventilation may cause an increase of temperature in the instrument, which would cause damage to the instrument. So please keep the instrument well ventilated and inspect the air outlet and the fan regularly.

1.5 Working Environment

Temperature

Operating: 0°C to +40°C

Non-operating: -20°C to +60°C

Humidity

- **Operating:**
0°C to +40°C: ≤80% RH (without condensation)
- **Non-operating:**
-20°C to +40°C: ≤90% RH (without condensation)
Below +60°C: ≤80% RH (without condensation)



WARNING

To avoid short circuit inside the instrument or electric shock, never operate the instrument in a humid environment.

Altitude

- **Operating:** below 3 km
- **Non-operating:** below 12 km

Protection Level Against Electric Shock

ESD $\pm 8\text{kV}$

Installation (Overvoltage) Category

This product is powered by mains conforming to installation (overvoltage) category II.



WARNING

Ensure that no overvoltage (such as that caused by a bolt of lightning) can reach the product. Otherwise, the operator might be exposed to the danger of an electric shock.

Installation (Overvoltage) Category Definitions

Installation (overvoltage) category I refers to signal level which is applicable to equipment measurement terminals connected to the source circuit. Among these terminals, precautions are done to limit the transient voltage to a low level.

Installation (overvoltage) category II refers to the local power distribution level which is applicable to equipment connected to the AC line (AC power).

Pollution Degree

Pollution Degree 2

Pollution Degree Definition

- **Pollution Degree 1:** No pollution or only dry, nonconductive pollution occurs. The pollution has no effect. For example, a clean room or air-conditioned office environment.
- **Pollution Degree 2:** Normally only nonconductive pollution occurs. Temporary conductivity caused by condensation is to be expected. For example, indoor environment.
- **Pollution Degree 3:** Conductive pollution or dry nonconductive pollution that becomes conductive due to condensation occurs. For example, sheltered outdoor environment.
- **Pollution Degree 4:** The pollution generates persistent conductivity caused by conductive dust, rain, or snow. For example, outdoor areas.

Safety Class

Class 2

1.6 Care and Cleaning

Care

Do not store or leave the instrument where it may be exposed to direct sunlight for long periods of time.

Cleaning

Clean the instrument regularly according to its operating conditions.

1. Disconnect the instrument from all power sources.
2. Clean the external surfaces of the instrument with a soft cloth dampened with mild detergent or water. Avoid having any water or other objects into the chassis via the heat dissipation hole. When cleaning the LCD, take care to avoid scarifying it.



CAUTION

To avoid damage to the instrument, do not expose it to caustic liquids.



WARNING

To avoid short-circuit resulting from moisture or personal injuries, ensure that the instrument is completely dry before connecting it to the power supply.

1.7 Environmental Considerations

The following symbol indicates that this product complies with the WEEE Directive 2002/96/EC.



The equipment may contain substances that could be harmful to the environment or human health. To avoid the release of such substances into the environment and avoid harm to human health, we recommend you to recycle this product appropriately to ensure that most materials are reused or recycled properly. Please contact your local authorities for disposal or recycling information.

You can click on the following link <https://int.rigol.com/services/services/declaration> to download the latest version of the RoHS&WEEE certification file.

2 Product Features

Product Features

- Max. sample rate: 625 MSa/s
- Max. output frequency: 50 MHz
- 16-bit vertical resolution
- Arbitrary waveform editing function with a max. Arb waveform length of 2 Mpts/CH (8 Mpts/CH optional)
- Built-in high-order harmonic generator (max. 20th order)
- Independent signal frequency measurement channel with a max. frequency of 500 MHz
- USB and LAN interfaces for remote connection
- Type-C power interface for powering the instrument with mobile power source, satisfying testing requirements in the field
- Standard Web Control function for easier remote cooperation

DG800 Pro series Function/Arbitrary Waveform Generator provides up to 625 MSa/s sample rate and 2 Mpts/CH memory depth (standard). It is a cost-effective function/arbitrary waveform generator that combines multiple functions including Function Generator, Arbitrary Waveform Generator, Noise Generator, Pulse Generator, Harmonic Generator, Analog/Digital Modulator and Counter.

3 Document Overview

This manual gives you a quick overview of the front and rear panels, user interface as well as basic operation methods of DG800 Pro series function/arbitrary waveform generator.



TIP

For the latest version of this manual, download it from RIGOL official website (www.rigol.com).

Publication Number

UGB14100-1110

Format Conventions in this Manual

1. Key

The front panel key is denoted by the menu key icon. For example,  indicates the "Default" key.

2. Menu

The menu item is denoted by the format of "Menu Name (Bold) + Character Shading" in the manual. For example, **Setup**.

3. Operation Procedures

The next step of the operation is denoted by ">" in the manual. For example, .

> **Utility** indicates first clicking or tapping  and then clicking or tapping **Utility**.

Content Conventions in this Manual

DG800 Pro series function/arbitrary waveform generator includes the following models. Unless otherwise specified, this manual takes the two-channel model DG852 Pro as an example to illustrate the functions and operation methods of DG800 Pro series.

Model	No. of Channels	Sample Rate	Max. Output Frequency
DG821 Pro	1	625 MSa/s	25 MHz
DG822 Pro	2	625 MSa/s	25 MHz
DG852 Pro	2	625 MSa/s	50 MHz

4 Quick Start

4.1 General Inspection

1. Inspect the packaging

If the packaging has been damaged, do not dispose the damaged packaging or cushioning materials until the shipment has been checked for completeness and has passed both electrical and mechanical tests.

The consigner or carrier shall be liable for the damage to the instrument resulting from shipment. RIGOL would not be responsible for free maintenance/rework or replacement of the instrument.

2. Inspect the instrument

In case of any mechanical damage, missing parts, or failure in passing the electrical and mechanical tests, contact your RIGOL sales representative.

3. Check the accessories

Please check the accessories according to the packing lists. If the accessories are damaged or incomplete, please contact your RIGOL sales representative.

Recommended Calibration Interval

RIGOL suggests that the instrument should be calibrated every 12 months.

4.2 Appearance and Dimensions

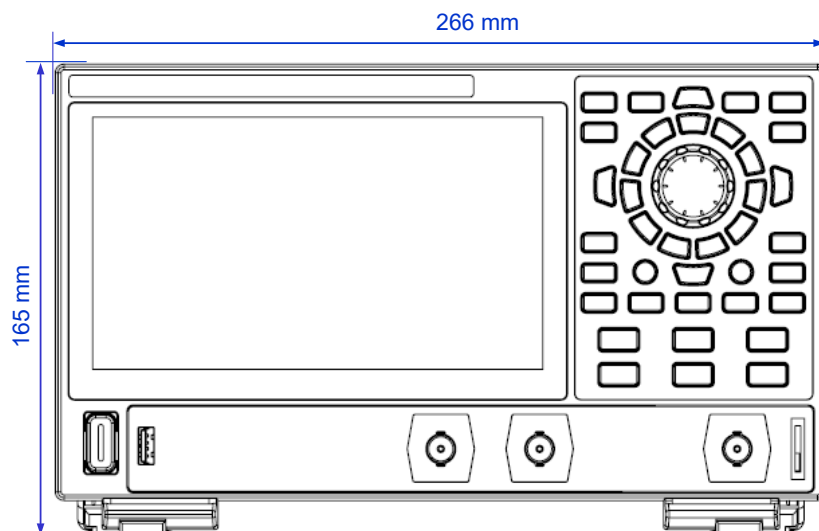

Figure 4.1 Front View

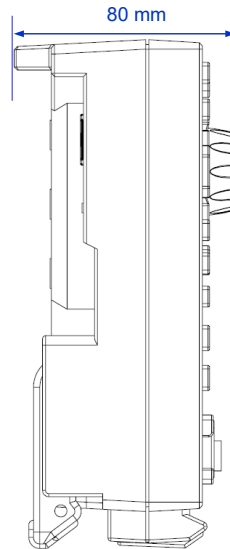

Figure 4.2 Side View

4.3 To Prepare for Use

4.3.1 To Connect to Power

The power requirements of this signal source are USB PD 15 V, 3 A. Please use the power adaptor provided in the accessories to connect the instrument to the AC power source (100 V to 240 V, 50 Hz to 60 Hz), as shown in the figure below. Apart from the instrument's standard power adaptor, this instrument also supports the power adaptor that conforms to the PD (Power Delivery) protocol. However, the adaptor should support 15 V 3 A 45 W output.

After the power is connected, the backlight of the front-panel power key can have the following three states:

- **Breathing Red:** indicates that the instrument is connected to a compliant power adaptor and is in standby state. At this time, you can press the power key to power on the instrument.
- **Solid Yellow:** indicates that the instrument does not detect a compliant power adaptor and cannot be powered on.
- **Solid Green:** indicates that the instrument is running normally.

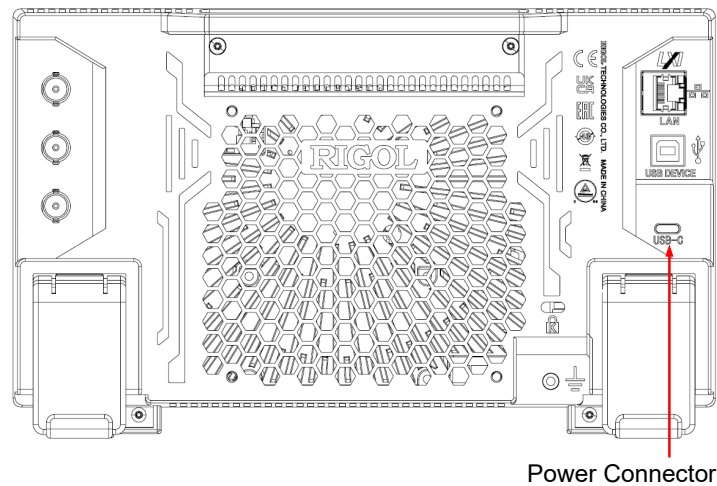

Figure 4.3 Connect to Power

Table 4.1 Power Adaptor Specifications

Item	Description
Input	100 V to 240 V, 50 Hz to 60 Hz, 1.6 A Max
Output	USB PD 15 V, 3 A, 45 W



CAUTION

The power adaptor provided in accessories can only be used to power RIGOL instruments. Do not use it for mobile phone and other devices.



WARNING

To avoid electric shock, please ensure that the instrument is correctly grounded.

4.3.2 Turn-on Checkout





After the instrument is connected to the power source, press **0** at the lower-left corner of the front panel to power on the instrument. During the start-up process, the instrument performs a series of self-tests. After the self-test, the splash screen is

displayed. You can also click or tap  > **Utility** > **Setup** to set the "Power Set" to "Auto". The instrument powers on once connected to power. If the instrument won't start, please refer to *Troubleshooting* to address it.



TIP

You can shut down the instrument in the following ways.

- Click or tap  > **Shut Down** or press the front-panel  and a dialog box "Do you need to shut down the instrument?" is displayed. Click or tap **Shut Down** to shut down the instrument.
- Press  twice to shut down the instrument.
- Press  for three seconds to shut down the instrument.

4.3.3 To Set the System Language

The instrument supports system languages including Chinese and English. You can

click or tap  > **Utility** > **Setup** to enter the basic settings menu. Then click or tap the drop-down button of **Language** to set the system language to Chinese or English.

4.4 Product Overview

This chapter introduces the appearance and dimensions, front and rear panels as well as the user interface (display) of the DG800 Pro series by taking DG852 Pro as an example.

4.4.1 Front Panel Overview

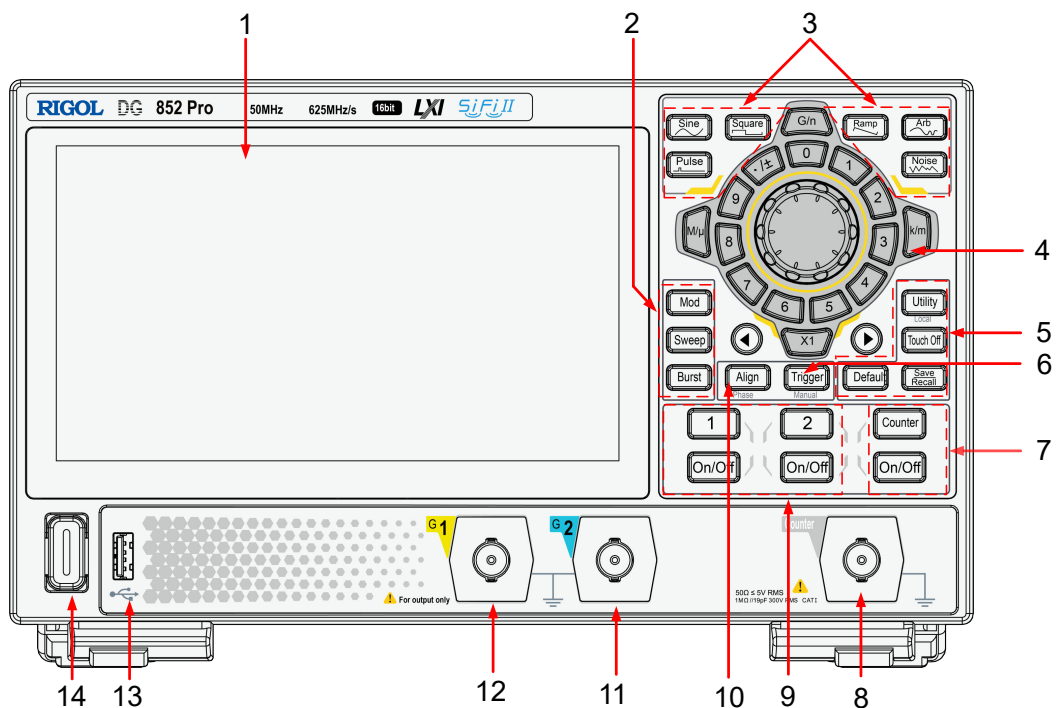





Figure 4.4 Front Panel







1. 7-inch Touch Screen

Displays the menu labels, parameter settings, system state, prompt messages, and other information.

2. Output Mode Selection Area

- : Modulation key. Press the key to set the output mode to Modulation for the current channel. Available modulated signals include AM, FM, PM, SUM, ASK, FSK, PSK, and PWM signals. For details about the Modulation mode, please refer to *Modulation*.
- : Sweep key. Press the key to set the output mode to Sweep for the current channel. For details about the Sweep mode, please refer to *Sweep*.
- : Burst key. Press the key to set the output mode to Burst for the current channel. For details about the Burst mode, please refer to *Burst*.

3. Basic Waveform Selection Area

- : Sine key. Press the key to set the basic waveform to Sine for the current channel. For details about the Sine waveform, please refer to *To Output Sine Wave*.
- : Square key. Press the key to set the basic waveform to Square for the current channel. For details about the Square waveform, please refer to *To Output Square Wave*.
- : Pulse key. Press the key to set the basic waveform to Pulse for the current channel. For details about the Pulse waveform, please refer to *To Output Pulse*.
- : Ramp key. Press the key to set the basic waveform to Ramp for the current channel. For details about the Ramp waveform, please refer to *To Output Ramp Wave*.
- : Arb key. Press the key to set the basic waveform to Arb for the current channel. For details about Arb, please refer to *To Output Arbitrary Waveforms*.
- : Noise key. Press the key to set the basic waveform to Noise for the current channel. For details about the Noise, please refer to *To Output Noise*.

4. Parameter Input Area

The parameter input area comprises a knob, a numeric keypad, unit keys, and arrow keys. For details about the parameter input method, please refer to *Parameter Setting Method*.

5. Quick Operation Keys

Utility: Utility/Local key. Press the key to enter the system utility function setting menu to set the remote interface parameters and system functions. You can also check the instrument information. When the instrument is in remote control mode, you can press this key to restore the instrument to local operation from remote control.

Touch Off: Touch Off key. Press the key to disable or enable the touch screen function.

Save Recall: Save/Recall key. Press the key to open or close the Store menu.

Default: Default key. Press the key and a dialog box is displayed. Click or tap **OK** to restore the instrument to its factory defaults.

6. Manual Trigger Key

When the instrument is set to manual trigger for Sweep/Burst mode, a sweep/burst output will be triggered manually each time you press **Trigger**.

7. Counter Control Area

Counter: Counter menu key. Press the key to open the counter menu.

On/Off: Counter On/Off Key. Press the key to enable or disable the Counter function. When the Counter function is enabled, the backlight of the key is illuminated; when the Counter function is disabled, the backlight is off.

8. Input Connector for the Signal Measured by Counter

BNC type connector. It is used to accept the signal measured by the counter.

9. Channel Output Control Area

1: CH1 selection key. Press the key to select CH1 as the current channel. You can set the waveforms, parameters and others for CH1 with the front-panel keys and knob. When CH1 is selected, the backlight of the key is illuminated.

2: CH2 selection key. Press the key to select CH2 as the current channel. You can set the waveforms, parameters and others for CH2 with the front-panel keys and knob. When CH2 is selected, the backlight of the key is illuminated.

On/Off: Channel on/off key. Press the key to enable or disable the corresponding channel output. When the channel output is enabled, the backlight of the corresponding key is illuminated.

10. Align Key

Press **Align** to align phase. For details, refer to *Align Phase*.

11. CH2 Output Connector

BNC type connector with 50 Ω nominal output impedance. When the CH2 output is enabled, the CH2 output connector outputs the waveform in the current configuration.

12. CH1 Output Connector

BNC type connector with 50 Ω nominal output impedance. When the CH1 output is enabled, the CH1 output connector outputs the waveform in the current configuration.

13. USB HOST Interface

Reads the waveform or state files stored in the USB storage device; saves the current instrument states or edited waveform data into the USB, or saves the content displayed on the screen to the USB in the format of a captured image. FAT32, NTFS, and exFAT formats are supported.

14. Power Key

Powers the signal generator on or off.

4.4.2 Rear Panel Overview

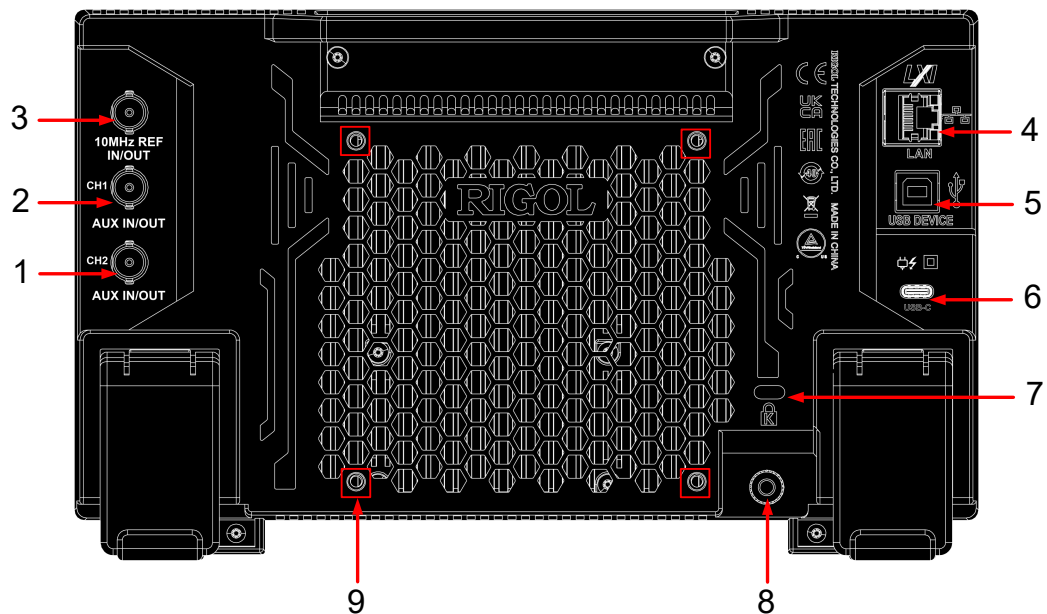

Figure 4.5 Rear Panel

1. [CH2 AUX IN/OUT]

BNC female connector. Its function is determined by the current work mode of CH2.

- **Sync output:** When the Sync output of CH2 is enabled, this connector outputs the corresponding sync signal that matches the current configuration of CH2.

For details about the characteristics of the sync signals corresponding to various output signals, please refer to *Sync Signal Setup*.

- **Modulation input:** when an external modulation source is selected for CH2, this connector accepts an external modulation signal. For details about external modulation, please refer to *Modulation*.
- **Trigger input:** when the Sweep or Burst mode is selected for CH2 and an external trigger source is selected, this connector accepts an external signal as the trigger signal of CH2. The polarity of the signal can be set.
- **Trigger output:** when the Sweep or Burst mode is selected for CH2 and the trigger output is enabled, this connector outputs a trigger signal with a specified edge type.

2. [CH1 AUX IN/OUT]

BNC female connector. Its function is determined by the current work mode of CH1.

- **Sync output:** When the Sync output of CH1 is enabled, this connector outputs the corresponding sync signal that matches the current configuration of CH1. For details about the characteristics of the sync signals corresponding to various output signals, please refer to *Sync Signal Setup*.
- **Modulation input:** when an external modulation source is selected for CH1, this connector accepts an external modulation signal. For details about external modulation, please refer to *Modulation*.
- **Trigger input:** when the Sweep or Burst mode is selected for CH1 and an external trigger source is selected, this connector accepts an external signal as the trigger signal of CH1. The polarity of the signal can be set.
- **Trigger output:** When the Sweep or Burst mode is selected for CH1 and the trigger output is enabled, this connector outputs a trigger signal with a specified edge type.

3. [10 MHz In/Out]

BNC female connector. Its function is determined by the clock type used by the instrument.

- When internal clock source is selected, this connector (as 10 MHz Out) outputs the 10 MHz clock signal generated by the internal crystal oscillator inside the generator.
- When external clock source is selected, this connector (as 10 MHz In) accepts an external clock signal.

This connector is usually used to synchronize multiple instruments. For clock source settings, refer to *Basic Settings*.

4. LAN

Connect the instrument to network via this interface. The instrument conforms to LXI CORE 2011 DEVICE instrument standard. Its test system can be built quickly. Then you can control the instrument by using the Web Control, sending SCPI commands via PC software, or use the user-defined programming.

5. USB DEVICE

Connect the instrument to the PC via this interface. Then you can use the PC software to send SCPI commands or use the user-defined programming to control the instrument.

6. USB Type-C Power Socket

The power requirements of the instrument are USB PD, 15 V, 3 A. Please use the power adaptor provided in the accessories to connect the instrument to the AC power source (100 V to 240 V, 50 Hz to 60 Hz).

7. Security Lock Hole

Use a standard PC/laptop lock cable to secure the instrument to a work bench or other location.

8. Ground Terminal

Connect the instrument chassis to the ground using the lead.

9. Mounting Screw Holes

Interval of screw holes: 100 mm x 100 mm. Use screws (M4*6-10) to secure the instrument to the bracket with the same screw hole interval.

4.4.3 User Interface Overview

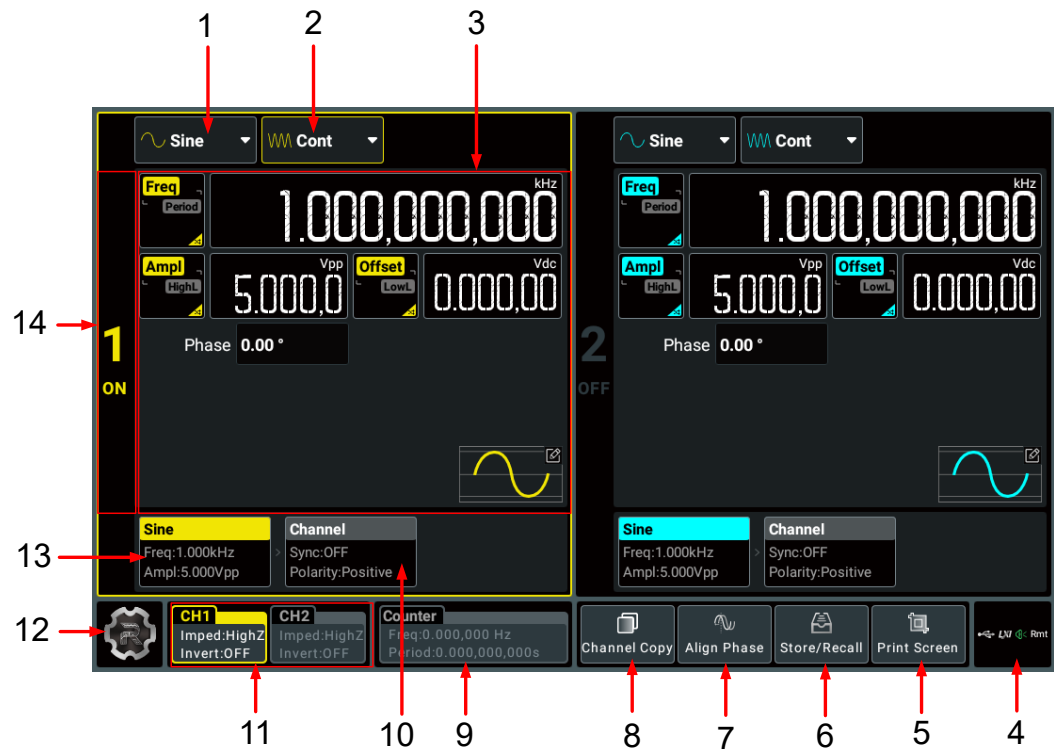

Figure 4.6 User Interface

1. Wave Type Drop-down Button

Click or tap the drop-down button to select the waveform type for the specified channel. Available waveform types are related to the current output mode.

2. Output Mode Drop-down Button



Click or tap the drop-down button to set the output mode to Continuous, Modulation, Sweep, Burst, or Sequence for the specified channel.



3. Parameter Configuration Area

You can set the waveform parameters and channel parameters for the corresponding channel in this area. When the counter is on, the CH2 configuration area is used to set the counter parameters.

4. Notification Area

Displays the USB icon, LAN icon, sound icon, and copy remote control icon. You can click or tap this area to open the "Utility" menu.

- USB storage device icon: When a USB storage device is detected,  will be displayed.
- LAN icon: When the LAN interface is successfully connected,  is displayed.

- Sound icon: In the "Utility" menu, click or tap **Setup** > **Beeper** to enable or disable the sound. When on,  will be displayed; when off,  will be displayed.
- Remote control icon: When the instrument is in remote control mode,  will be displayed.
- Date and Time: When the "Show Time" is set to On, the system date and time will be displayed.

5. Print Screen Key

Click or tap this key to capture the current screen and save the picture to internal memory.

6. Store/Recall Key

Click or tap the key to open the storage setting menu.

7. Align Phase Key

Click or tap the key to perform the phase alignment operation. For details, please refer to [Align Phase](#).

8. Channel Copy Key

Click or tap this key to open the channel copy menu. You can copy all states and waveforms of one channel to the other one. For details, please refer to [Channel Copy](#).

9. Counter Label

Displays the frequency value and period value measured by the counter. When the counter is turned on, this label is illuminated and displays the frequency and period measured by the counter.

10. Channel Tab

Displays the sync on/off status and polarity for the corresponding channel. You can click or tap this tab to switch to the channel setup interface.

11. Channel Labels

Display the channel on/off state (the "CH1"/"CH2" is illuminated or not), the selected channel (the label is highlighted or not), the impedance, and invert on/off setting. You can click or tap the label to select the specified channel.

12. Function Navigation Icon

Click or tap the icon to open the function navigation menu in which you can access the specified function menu by clicking or tapping the corresponding function key (Utility, Preset, Help, Coupling, Shut Down).

13. Waveform Tab

Displays the selected continuous waveform type, frequency, and amplitude. You can click or tap this tab to switch to the waveform parameter setting interface.

14. Channel Identifier

Identifies the area as CH1 ("1") or CH2 ("2") and indicates the on/off state of the channel. You can simply click or tap the area to enable or disable the corresponding channel output.

4.5 Touch Screen Gestures

The instrument provides a capacitive touch screen, which is convenient for you to operate and make configurations. It features great convenience, high flexibility, and great sensitivity. The actions supported by the touch screen controls include tapping and dragging.

4.5.1 Tap

Use one finger to tap the symbol or characters on the screen slightly, as shown in *Figure 4.7*. With the Tap gesture, you can perform the following operations:

- Tap the menu displayed on the screen to operate on the menu.
- Tap the function navigation icon at the lower-left corner of the touch screen to enable the function navigation.
- Tap the displayed numeric keypad to set the parameters.
- Tap the virtual keypad to set the filename.
- Tap the close button at the upper-right corner of the message box to close the prompt window.
- Tap other windows on the touch screen and operate on the windows.



Figure 4.7 Tap Gesture

4.5.2 Drag

Use one finger to select the object, and then drag the object to a destination place, as shown in [Figure 4.8](#). You can drag the window controls to change the position of the window (e.g. numeric keypad).

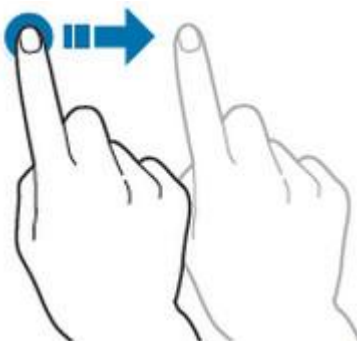

Figure 4.8 Drag Gesture

4.6 Parameter Setting Method

This instrument allows you to use the front-panel parameter input area and the touch screen to set parameters for the instrument.



NOTE

This manual mainly introduces how to set the parameters using the touch screen.

4.6.1 To Set Parameters with the Front-panel Keys and Knobs

You can use the front-panel parameter input area to set some parameters of the instrument. The parameter input area consists of a knob, a numeric keypad, unit selection keys, and arrow keys, as shown in the figure below.

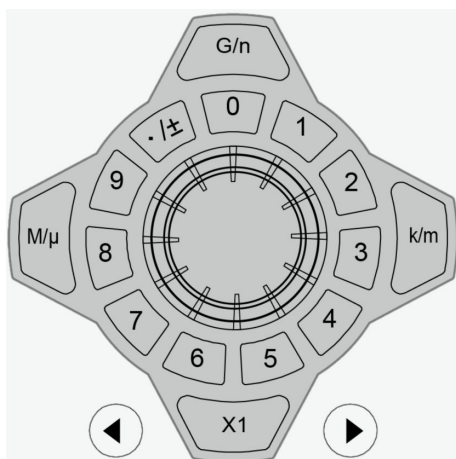

Knob



You can rotate the knob to move the cursor and navigate through the menu items. Then perform the following operations:

- **If the cursor selects a parameter input field**, you can press the knob to enter the parameter editing mode. Then you can use the front-panel arrow keys to move the cursor to select the digit place to be modified. Rotate the knob clockwise to increment the value at the selected digit place or counter-clockwise to decrement the value. Press the knob again to confirm the parameter setting and disable the parameter editing mode.
- **If the cursor selects a drop-down button**, you can press the knob to expand the drop-down menu and then rotate the knob to select a parameter in the menu. After that, press the knob again to confirm your selection and collapse the drop-down menu.
- **If the cursor selects a key, on/off switch, or tab control**, pressing the knob is equivalent to tapping the corresponding key, on/off switch, or tab control using the touch screen.

Numeric Keypad









Ring-type numeric keypad composed of numeric keys (from 0 to 9) and the decimal point/symbol key. If the current cursor selects the input field, you can press the





numeric key to input a number and press  to input ".", "-", or "+". When using the ring-type numeric keypad, you can also perform the following operations:

- Press the knob to confirm the input.
- Press  to delete characters.
- Press  to cancel the input.

Unit Selection Keys

When setting a parameter with the ring-type numeric keypad on the front panel, you can use the keys to select the unit of the parameter.

-  : sets the parameter unit to the default one. For example, when setting the phase, press  >  to set the phase to 1°; when setting the frequency, press  >  to set the frequency to 1 Hz.
-  /  /  : when setting the frequency, use the unit (M/k/G) before "/"; when setting time/amplitude/offset, use the unit (μ/m/n) after "/". For example,



when setting the frequency, press  >  to set the frequency to 1 kHz; when setting the period, press  >  to set the period to 1 ms.



TIP

When the set value exceeds the limit value, the instrument automatically adjusts the parameter to meet the requirements.

Arrow keys

- In normal mode, you can use the keys to move the cursor to select the desired menu item. It is equivalent to rotating the knob.
- In parameter editing mode, you can use the keys to select the digit place to be modified.
- When inputting parameters using the ring-type numeric keypad,  is used to delete the character while  is used to cancel the input and close the input field.

4.6.2 To Set Parameters with the Touch Screen

For this instrument, you can use the touch screen function to set all of its parameters. Click or tap the parameter input field and a virtual keypad will be displayed. You can use the pop-up keypad to complete your parameter setting. The method of using the virtual keypad is as follows.

Input Chinese and English Characters

For naming a file, this instrument supports both Chinese and English input methods. The following part introduces how to input Chinese and English characters with the Chinese/English input method.

- **Input English Characters**

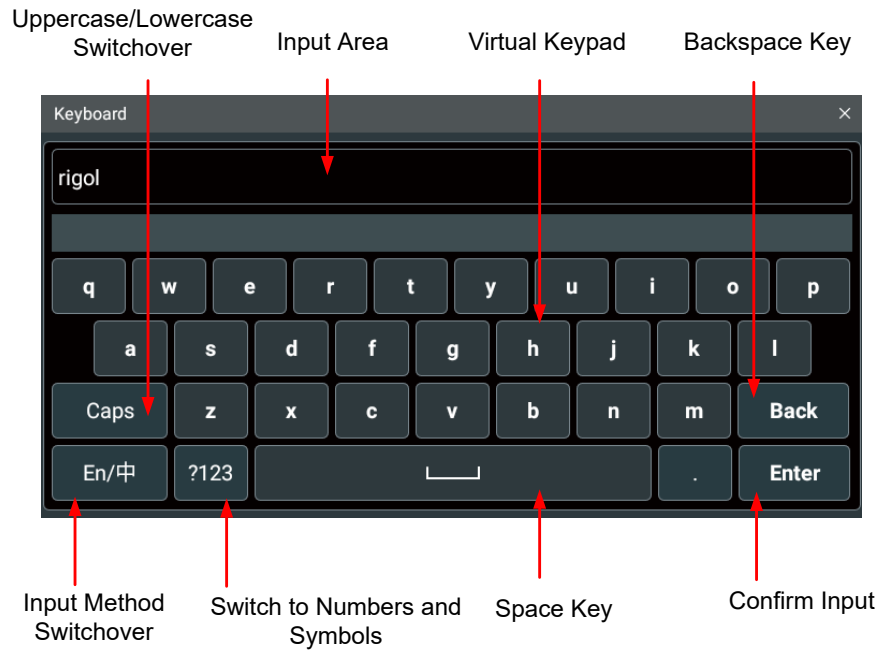

Figure 4.9 English Input Interface

1. Select the English input method

First check the input method type. If it shows "En/中", then go to Step 2; if it shows "中/En", click or tap the input method switchover key to switch to "En/中" (English input method).

2. Clear the name input area

If there is no character in the "Input Area", please go to the next step. If there are characters in the "Input Area", click or tap the "Back" key to delete all the characters from the "Input Area" in order.

3. Input the upper-case letter

If you want to input an upper-case letter, first use the Caps key to switch between the upper-case and lower-case modes. If the Caps key is selected, input the upper-case letter with the virtual keypad. If not, first click or tap the Caps key to ensure it is selected, then input the upper-case letter. All the input letters will be displayed in the "Input Area".

4. Input the lower-case letter

Refer to the operation specified in the previous step. If the Caps key is not selected, directly input the lower-case letter.

5. Input numbers or symbols

If the letter keypad is displayed, you need to click or tap the numeric switchover key to switch to the numeric keypad, and input numbers or symbols with the numeric keypad. All the input letters will be displayed in the "Input Area".

6. Modify or delete the unwanted characters that have been input

During the name input process, you can modify or delete the unwanted character if necessary. To delete the characters that have been input, click or tap the "Back" key in the virtual keypad. To modify the characters that have been input, delete the unwanted characters first and then input the new characters.

You can directly move the cursor to the character to be modified or deleted, delete the desired character or input the new characters after deleting the unwanted character.

7. Confirm the input

After completing the input operation, click or tap "Enter".

- **Input Chinese Characters**

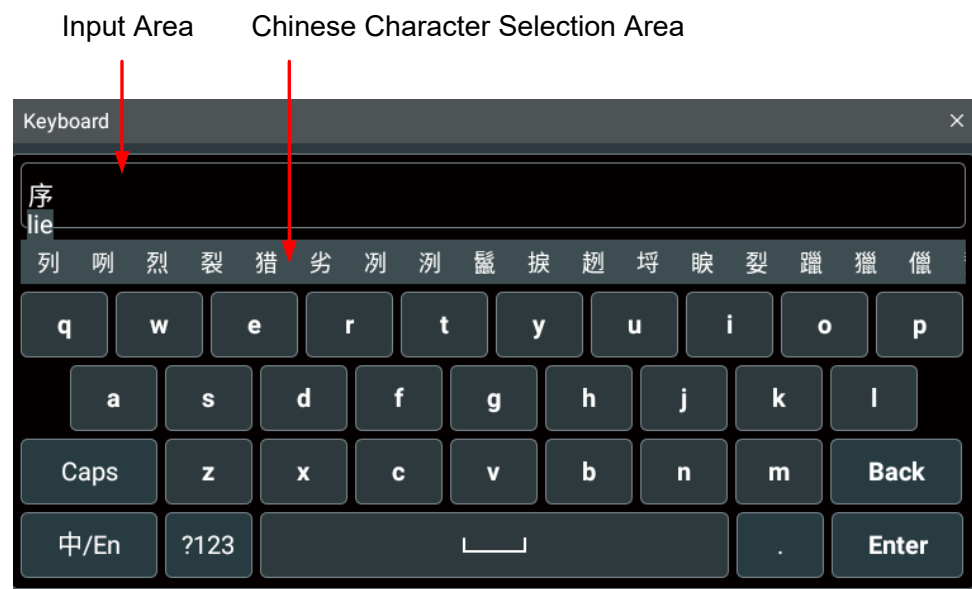

Figure 4.10 Chinese Input Interface

1. Select the Chinese input method

First check the input method type. If it shows "中/En", then go to Step 2; if it shows "En/中", click or tap the input method switchover key to switch to "中/En" (Chinese input method).

2. Clear the name input area

If there is no character in the "Input Area", please go to the next step. If there are characters in the "Input Area", click or tap the "Back" key to delete all the characters from the "Input Area" in order.

3. Input Chinese characters

Click or tap the virtual keypad to input Pinyin into the input area, then the characters to be selected will be displayed in the "Chinese Character Selection

Area". Slide to view more Chinese characters for you to choose. Select the desired Chinese character, and then the selected character will be displayed in the input area.

4. Modify or delete the unwanted characters that have been input

During the name input process, you can modify or delete the unwanted character if necessary. To delete the characters that have been input, click or tap the "Back" key in the virtual keypad. To modify the characters that have been input, delete the unwanted characters first and then input the new characters.

5. Confirm the input

After completing the input operation, click or tap "Enter".

Input a Value

When setting or modifying a function parameter, you can input an appropriate value with the numeric keypad.

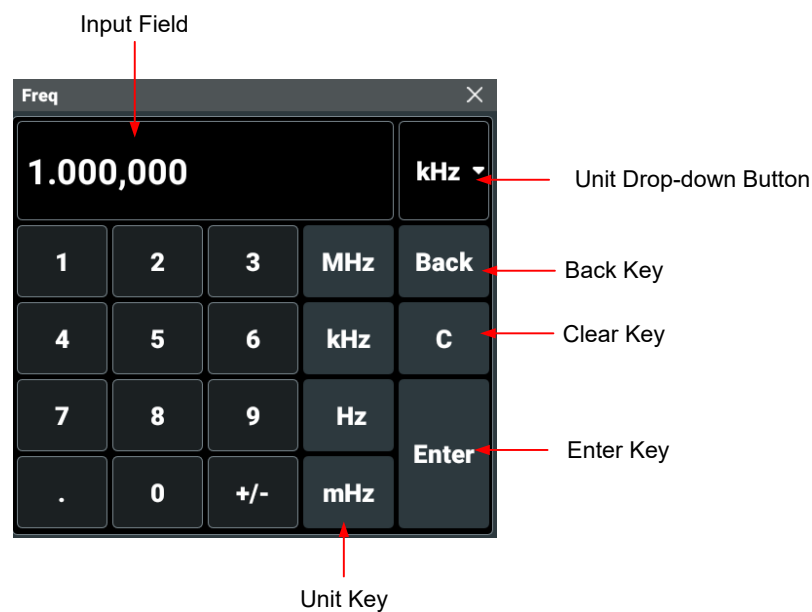



Figure 4.11 Numeric Keypad

Use the numeric keys in the numeric keypad to input a value. Then select the desired unit, and the numeric keypad is turned off automatically. This indicates that you have completed the parameter setting. The unit drop-down menu includes all available units. You can also click or tap the unit drop-down button to select the desired unit when multiple units are available. Then click or tap "Enter" to confirm input and close the numeric keypad.

4.7 To Use the Built-in Help System

The built-in help file provides information about the functions and menu

introductions of the instrument. Click or tap  > **Help** to enter the help system.

In the help system, you can get its help information by clicking on or tapping the link for the specified chapter.

4.8 To View the Option Information and Install the Option

DG800 Pro provides performance upgrade options to fulfill your measurement requirements. If you need any of these options, please order them according to the Order No. available in *Appendix A: Options and Accessories*, and then install the options by referring to this section. Besides, you can also view all the options of the instrument or activate the newly purchased option.

View Options

Click or tap the navigation icon  > **Utility** to enter the Utility menu. Click or tap **Options** to view the option installation information.

Install the option

The option license is a string of fixed characters. The license file should be in a specific format, with the filename extension ".lic". After you purchase an option, you will obtain a key (used for obtaining desired the option license code). Then, you can install the option according to the following steps.

1. Obtain an option license

- a. Log in to the RIGOL official website (<http://www.rigol.com>), click **SERVICE CENTRE > License Activation** to enter the software license registration;
- b. In the software license registration interface, input the correct key, serial number (click or tap  > **Utility** > **About** to obtain the serial number of the instrument), and verification code. Then click **Generate** to obtain the option license. If you need to use the file, please download it to the USB storage device.

2. Install the option

You can install the option in the following ways:

- Open the file (*.lic) to obtain the license. Use the :SYSTEM:LiCense:INSTall "<License>" command to install the option.

- Save the license file to the USB storage device and connect the USB correctly to the instrument (you can also save the file to the C disk). Then use the `SYSTem:LICense:INSTall:UDISK "<path>"` command to install the option.
- Save the license file to the USB storage device, connect the USB correctly to the instrument (you can also save the file to the C disk). Then click or tap **Store/Recall** to open the "Store" menu. Select the license file and then click or tap **Option** to install the option.

After installation, a prompt message "Option activated successfully" is displayed.

**TIP**

- For SCPI commands, refer to *DG800 Pro/DG900 Pro Programming Guide*.
- During the installation process, you are not allowed to power off the instrument.
- You are not allowed to modify the license filename.

5 Continuous

Click or tap the "Output Mode" drop-down button to select "Cont" and configure the channel to output continuous waveform. The Continuous setting interface is as shown in the figure below.

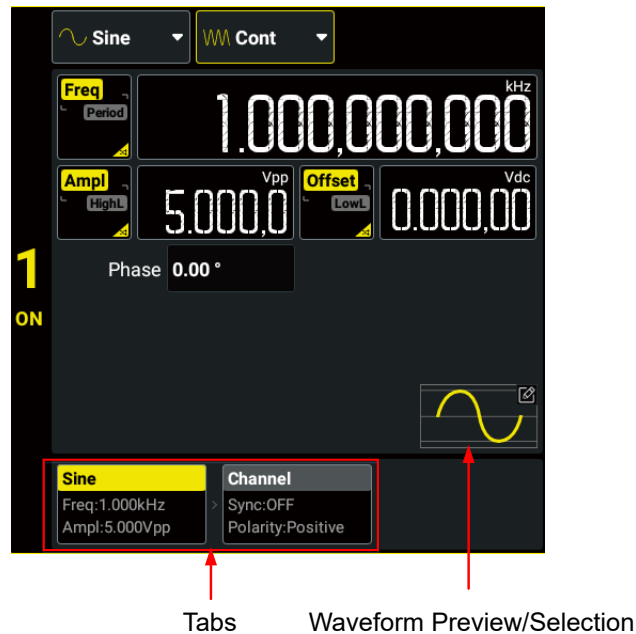

Figure 5.1 Continuous Setting Interface

After setting the output mode to "Cont", you can configure the selected channel to output the following waveforms and then view the created waveform in the waveform preview area.

- Sine Wave
- Square Wave
- Ramp Wave
- Pulse
- Noise
- Arbitrary Waveforms
- Harmonic

The following table shows the range of the frequency for different waveforms.

Table 5.1 Range of Continuous Waveform Frequency

Waveform	DG821 Pro	DG822 Pro	DG852 Pro
Sine	1 μ Hz to 25 MHz	1 μ Hz to 25 MHz	1 μ Hz to 50 MHz
Square	1 μ Hz to 20 MHz	1 μ Hz to 20 MHz	1 μ Hz to 40 MHz
Ramp	1 μ Hz to 1 MHz	1 μ Hz to 1 MHz	1 μ Hz to 1 MHz
Pulse	1 μ Hz to 10 MHz	1 μ Hz to 10 MHz	1 μ Hz to 25 MHz
Standard Arb	1 μ Hz to 10 MHz	1 μ Hz to 10 MHz	1 μ Hz to 15 MHz
Harmonic	1 mHz to 10 MHz	1 mHz to 10 MHz	1 mHz to 25 MHz

5.1 To Output Sine Wave

You can configure the instrument to output sine wave in the following ways.

- In the Continuous Setting Interface (*Figure 5.1*), click or tap the "Wave Type" drop-down button to select "Sine".
- In the Continuous Setting Interface (*Figure 5.1*), click or tap the "Waveform Preview/Selection" area and then select **Sine** in the displayed built-in waveform selection menu.
- Press the front-panel  key.

In the setting interface for Sine wave, you can set the following parameters to create different sine waves as desired.

Frequency/Period

Click or tap the **Freq/Period** button to set the parameter to "Freq". "Freq" is now highlighted. Click or tap its input field and use the pop-up numeric keypad to set the frequency for sine wave. By default, the frequency for sine wave is 1 kHz, and the resolution is 1 μ Hz. For available ranges of the sine frequency of different models, please refer to *Table 5.1 Range of Continuous Waveform Frequency*. You can click or tap the button again to toggle the parameter to "Period". Period = 1/Frequency.

Amplitude/High Level

Click or tap the **Ampl/HighL** button to set the parameter to "Ampl". "Ampl" is now highlighted. Click or tap its input field and use the pop-up numeric keypad to set the amplitude for sine wave. Available units for amplitude include Vpp, Vrms, and dBm (not available in HighZ) The amplitude for sine wave is 5 Vpp by default. Available range of amplitude is related to the "Impedance" setting.

- HighZ: 2 mVpp to 20 Vpp.
- Load (50 Ω): 1 mVpp to 10 Vpp.

Click or tap the button again to toggle the parameter to "HighL". High Level = Offset + Amplitude/2. The high level range is related to the low level setting value. That is, high level minus low level cannot exceed the current range of amplitude.



NOTE

1. How to convert the amplitude in Vpp to the corresponding value in Vrms?

Vpp is the unit for signal peak-peak value and Vrms is the unit for signal effective value. The default unit is Vpp. When setting the amplitude with the pop-up numeric keypad, you can click or tap the unit drop-down button to select the desired unit and then click or tap "Enter" to confirm the current amplitude unit setting. You cannot set the amplitude in dBm or Vrms for Arb and Harmonic.

The relationship between Vpp and Vrms varies for different waveforms. Take sine wave as an example. The relationship between the two units is as shown in the figure below.

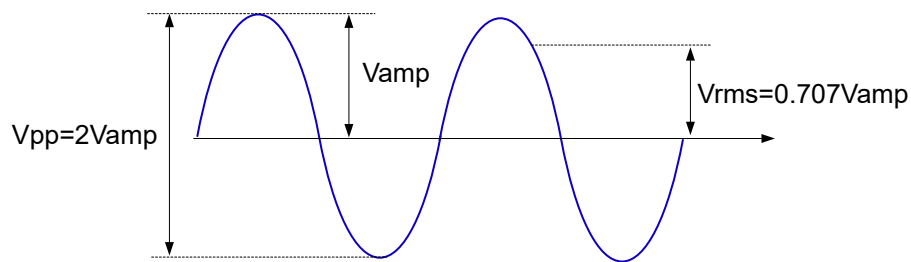

According to the figure above, the conversion relationship between Sine Vpp and Vrms fulfills the following equation:

$$V_{pp} = 2\sqrt{2} V_{rms}$$

2. How to set the waveform amplitude in the unit of dBm?

- Set the impedance to "Load" (refer to *Impedance*).
- When setting the amplitude, click or tap the unit drop-down button to select "dBm" in the pop-up numeric keypad.
- Input the desired value and then click or tap "Enter" to set the waveform amplitude in dBm.

dBm is the unit for signal power absolute value. The relationship between dBm and Vrms fulfills the following equation:

$$dBm = 10 \lg \left(\frac{V_{rms}^2}{R} \times \frac{1}{0.001W} \right)$$

W is the unit of the signal power. R represents the channel output impedance value which must be a certain value. Therefore, dBm is not available when the output impedance is set to "HighZ".

Offset/Low Level

Click or tap the **Offset/LowL** button to set the parameter to "Offset". "Offset" is now highlighted. Click or tap its input field and use the pop-up numeric keypad to set the offset for sine wave. The range of offset is limited by the "Impedance" and "Amplitude/High Level" setting. The default value is 0 Vdc.

Click or tap the button again to toggle the parameter to "LowL". Low Level = Offset - Amplitude/2. The low level range is related to the high level setting value. That is, high level minus low level cannot exceed the current range of amplitude.

TIP

The "Ampl" and "Offset" buttons appear at the same time, so are "HighL" and "LowL" buttons. For example, selecting "Offset" automatically toggles the "Ampl/HighL" parameter to "Ampl".

Starting Phase

Click or tap the **Phase** input field to set the starting phase, which ranges from -360° to 360° . The default phase is 0° , and the resolution is 0.01° .

Channel Setup

You can also click or tap the "Channel" tab in the *Continuous* interface to access the channel setup interface to configure channel output. For details, please refer to *Channel Setup*.

Enable the Channel Output

After setting the waveform parameters, you need to enable the channel to output waveforms. You can enable the channel output in the following ways.

- Click or tap the channel label at the bottom of the screen.
- Press the front-panel  key of the corresponding channel.
- Click or tap the channel identifier at the left side of the parameter configuration area.

5.2 To Output Square Wave

You can configure the instrument to output square wave in the following ways.

- In the Continuous Setting Interface (*Figure 5.1*), click or tap the "Wave Type" drop-down button to select "Square".
- In the Continuous Setting Interface (*Figure 5.1*), click or tap the "Waveform Preview/Selection" area and then select **Square** in the displayed built-in waveform selection menu.
- Press the front-panel  key.

In the setting interface for Square wave, you can set the following parameters to create different square waves as desired.

Frequency/Period

Click or tap the **Freq/Period** button to set the parameter to "Freq". "Freq" is now highlighted. Click or tap its input field and use the pop-up numeric keypad to set the frequency for square waveform. By default, the frequency for square is 1 kHz and the resolution is 1 μ Hz. For available ranges of the square frequency of different models, please refer to [Table 5.1 Range of Continuous Waveform Frequency](#). You can click or tap the button again to toggle the parameter to "Period". $\text{Period} = 1/\text{Frequency}$.

Amplitude/High Level

Click or tap the **Ampl/HighL** button to set the parameter to "Ampl". "Ampl" is now highlighted. Click or tap its input field and use the pop-up numeric keypad to set the amplitude for square waveform. Available units for amplitude include Vpp, Vrms, and dBm (not available in HighZ). For how to set the amplitude in Vrms or dBm, please refer to [To Output Sine Wave](#). The amplitude for square wave is 5 Vpp by default. Available range of amplitude is related to the "Impedance" setting.

- HighZ: 2 mVpp to 20 Vpp.
- Load (50 Ω): 1 mVpp to 10 Vpp.

Click or tap the button again to toggle the parameter to "HighL". $\text{High Level} = \text{Offset} + \text{Amplitude}/2$. The high level range is related to the low level setting value. That is, high level minus low level cannot exceed the current range of amplitude.

Offset/Low Level

Click or tap the **Offset/LowL** button to set the parameter to "Offset". "Offset" is now highlighted. Click or tap its input field and use the pop-up numeric keypad to set the offset for square waveform. The range of offset is limited by the "Impedance" and "Amplitude/High Level" setting. The default value is 0 Vdc.

Click or tap the button again to toggle the parameter to "LowL". $\text{Low Level} = \text{Offset} - \text{Amplitude}/2$. The low level range is related to the high level setting value. That is, high level minus low level cannot exceed the current range of amplitude.

TIP

The "Ampl" and "Offset" buttons appear at the same time, so are "HighL" and "LowL" buttons. For example, selecting "Offset" automatically toggles the "Ampl/HighL" parameter to "Ampl".

Starting Phase

Click or tap the **Phase** input field to set the starting phase, which ranges from -360° to 360° . The default phase is 0° , and the resolution is 0.01° .



Duty Cycle

Duty cycle represents the amount of time per period that the square wave is at a high level, as shown in the figure below. The "Duty Cycle" parameter setting only appears when "Square" or "Pulse" is selected.

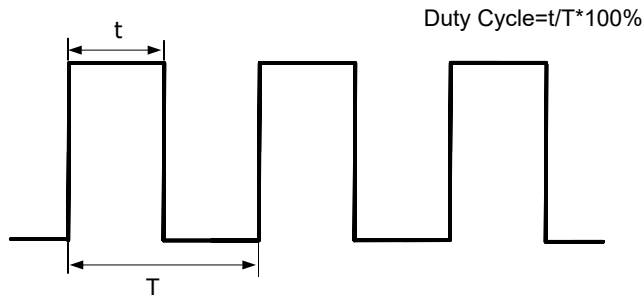

Click or tap the **Duty Cycle** input field to set the duty cycle. The available range is from 0.01% to 99.99% (depending on the Frequency/Period setting). By default, it is 50%, and the resolution is 0.01%.

Channel Setup

You can also click or tap the "Channel" tab in [Figure 5.1](#) interface to access the channel setup interface to configure channel output. For details, please refer to [Channel Setup](#).

Enable the Channel Output

Refer to [Enable the Channel Output](#) of the "To Output Sine Wave" section.

5.3 To Output Ramp Wave

You can configure the instrument to output ramp wave in the following ways.

- In the Continuous Setting Interface ([Figure 5.1](#)), click or tap the "Wave Type" drop-down button to select "Ramp".
- In the Continuous Setting Interface ([Figure 5.1](#)), click or tap the "Waveform Preview/Selection" area and then select **Ramp** in the displayed built-in waveform selection menu.
- Press the front-panel  key.

In the setting interface for Ramp wave, you can set the following parameters to create different ramp waves as desired.

Frequency/Period

Click or tap the **Freq/Period** button to set the parameter to "Freq". "Freq" is now highlighted. Click or tap its input field and use the pop-up numeric keypad to set the frequency for ramp waveform. By default, the frequency for ramp wave is 1 kHz and the resolution is 1 μ Hz. For available ranges of the ramp frequency of different

models, please refer to [Table 5.1 Range of Continuous Waveform Frequency](#). You can click or tap the button again to toggle the parameter to "Period". $\text{Period} = 1/\text{Frequency}$.

Amplitude/High Level

Click or tap the **Ampl/HighL** button to set the parameter to "Ampl". "Ampl" is now highlighted. Click or tap its input field and use the pop-up numeric keypad to set the amplitude for ramp wave. Available units for amplitude include Vpp, Vrms, and dBm (not available in HighZ). For how to set the amplitude in Vrms or dBm, please refer to [To Output Sine Wave](#). The amplitude for Ramp wave is 5 Vpp by default. The range of amplitude is related to the "Impedance" setting.

- HighZ: 2 mVpp to 20 Vpp.
- Load (50 Ω): 1 mVpp to 10 Vpp.

Click or tap the button again to toggle the parameter to "HighL". $\text{High Level} = \text{Offset} + \text{Amplitude}/2$. The high level range is related to the low level setting value. That is, high level minus low level cannot exceed the current range of amplitude.

Offset/Low Level

Click or tap the **Offset/LowL** button to set the parameter to "Offset". "Offset" is now highlighted. Click or tap its input field and use the pop-up numeric keypad to set the offset for ramp waveform. The range of offset is limited by the "Impedance" and "Amplitude/High Level" setting. The default value is 0 Vdc.

Click or tap the button again to toggle the parameter to "LowL". $\text{Low Level} = \text{Offset} - \text{Amplitude}/2$. The low level range is related to the high level setting value. That is, high level minus low level cannot exceed the current range of amplitude.

TIP

The "Ampl" and "Offset" buttons appear at the same time, so are "HighL" and "LowL" buttons. For example, selecting "Offset" automatically toggles the "Ampl/HighL" parameter to "Ampl".

Starting Phase

Click or tap the **Phase** input field to set the starting phase, which ranges from -360° to 360° . The default phase is 0° , and the resolution is 0.01° .

Symmetry

Symmetry is defined as the percentage of the amount of time Ramp wave is rising in the period, as shown in the figure below. It only appears when "Ramp" is selected.



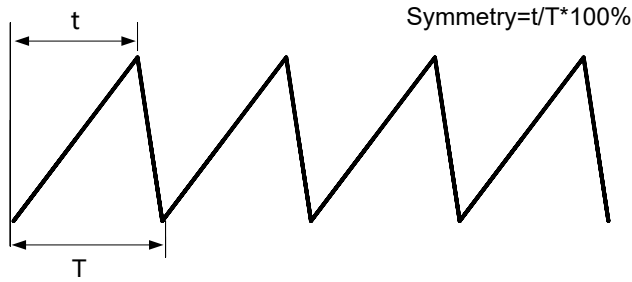

Click or tap the **Symmetry** input field to set the symmetry, which ranges from 0% to 100%. The default value is 50%, and the resolution is 0.1%.

Channel Setup

You can also click or tap the "Channel" tab in the *Continuous* interface to access the channel setup interface to configure channel output. For details, please refer to *Channel Setup*.

Enable the Channel Output

Refer to *Enable the Channel Output* of the "To Output Sine Wave" section.

5.4 To Output Pulse

You can configure the instrument to output Pulse in the following ways.

- In the Continuous Setting Interface (*Figure 5.1*), click or tap the "Wave Type" drop-down button to select "Pulse".
- In the Continuous Setting Interface (*Figure 5.1*), click or tap the "Waveform Preview/Selection" area and then select **Pulse** in the displayed built-in waveform selection menu.
- Press the front-panel  key.

In addition to basic parameters (e.g. Frequency, Amplitude, Offset, Starting Phase, High Level, Low Level) mentioned before, you also need to set the "Pulse Width/Duty Cycle", "Rising Edge", and "Falling Edge".

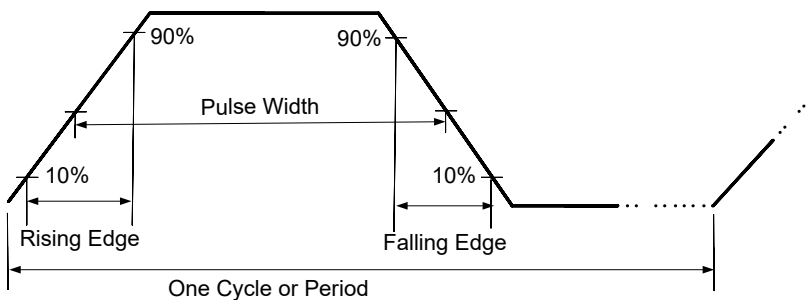

Frequency/Period

Click or tap the **Freq/Period** button to set the parameter to "Freq". "Freq" is now highlighted. Click or tap its input field and use the pop-up numeric keypad to set the frequency for pulse waveform. By default, the frequency for Pulse is 1 kHz and the resolution is 1 μ Hz. For available ranges of the pulse frequency of different models, please refer to [Table 5.1 Range of Continuous Waveform Frequency](#). You can click or tap the button again to toggle the parameter to "Period". Period = 1/Frequency.

Amplitude/High Level

Click or tap the **Ampl/HighL** button to set the parameter to "Ampl". "Ampl" is now highlighted. Click or tap its input field and use the pop-up numeric keypad to set the amplitude for pulse waveform. Available units for amplitude include Vpp, Vrms, and dBm (not available in HighZ). For how to set the amplitude in Vrms or dBm, please refer to [To Output Sine Wave](#). The amplitude for pulse wave is 5 Vpp by default. The range of amplitude is related to the "Impedance" setting.

- HighZ: 2 mVpp to 20 Vpp.
- Load (50 Ω): 1 mVpp to 10 Vpp.

Click or tap the button again to toggle the parameter to "HighL". High Level = Offset + Amplitude/2. The high level range is related to the low level setting value. That is, high level minus low level cannot exceed the current range of amplitude.

Offset/Low Level

Click or tap the **Offset/LowL** button to set the parameter to "Offset". "Offset" is now highlighted. Click or tap its input field and use the pop-up numeric keypad to set the offset for pulse waveform. The range of offset is limited by the "Impedance" and "Amplitude/High Level" setting. The default value is 0 Vdc.

Click or tap the button again to toggle the parameter to "LowL". Low Level = Offset - Amplitude/2. The low level range is related to the high level setting value. That is, high level minus low level cannot exceed the current range of amplitude.

TIP

The "Ampl" and "Offset" buttons appear at the same time, so are "HighL" and "LowL" buttons. For example, selecting "Offset" automatically toggles the "Ampl/HighL" parameter to "Ampl".

Starting Phase

Click or tap the **Phase** input field to set the starting phase, which ranges from -360° to 360°. The default phase is 0°, and the resolution is 0.01°.

Pulse Width/Duty Cycle

Pulse width is the time from the 50% threshold of a pulse's rising edge to the 50% threshold of the next falling edge, as shown in the figure above. The pulse duty cycle



is defined as the percentage of the pulse width to the pulse period. Changing one of them automatically modifies the other.

Click or tap the **Width/Duty** button to set the parameter to "Width". "Width" is now highlighted. Click or tap its input field and use the pop-up numeric keypad to set the pulse width. The available range is from 9 ns to 999 ks. The default value is 500 μ s and the resolution is 0.1 ns.

Click or tap the button to toggle the parameter to "Duty". Duty Cycle = Pulse Width/Period. The available range is from 0.01% to 99.99%. The default value is 50% and the resolution is 0.01%.



TIP

- The pulse width must conform to the following restrictions determined by the period and the minimum pulse width (W_{min} : 9 ns): Minimum Pulse Width \leq Pulse Width \leq (Period - Minimum Pulse Width), and Period*0.01% \leq Pulse Width \leq Period*99.99%.
- The pulse duty cycle must conform to the following restrictions determined by the minimum pulse width and pulse period: (Minimum Pulse Width/Period)*100% \leq Pulse Duty Cycle \leq (1 - Minimum Pulse Width/Period)*100%.

Leading/Trailing Edge

The leading (rising) edge time is the time it takes for the pulse level to go from 10% to 90%; trailing (falling) edge time is the time it takes for the pulse level to go from 90% to 10%.

Click or tap the **Leading/Trailing** input field and use the pop-up numeric keypad to set the leading edge time/trailing edge time. The leading/trailing edge time ranges from 3 ns to 1 s. The default value is 3 ns and the resolution is 0.1 ns.



TIP

The range of the trailing edge time is limited by the current waveform frequency, pulse width, and leading edge time. The range of the leading edge time is limited by the current waveform frequency and pulse width. When the set value exceeds the limits, the instrument will adjust the edge time automatically.

Channel Setup

You can also click or tap the "Channel" tab in *Continuous* interface to access the channel setup interface to configure channel output. For details, please refer to *Channel Setup*.

Enable the Channel Output

Refer to *Enable the Channel Output* of the "To Output Sine Wave" section.

5.5 To Output Noise

You can configure the instrument to output noise in the following ways.

- In the Continuous Setting Interface (*Figure 5.1*), click or tap the "Wave Type" drop-down button to select "Noise".
- In the Continuous Setting Interface (*Figure 5.1*), click or tap the "Waveform Preview/Selection" area and then select **Noise** in the displayed built-in waveform selection menu.
- Press the front-panel  key.

In the setting interface for Noise, you can set the following parameters to create different noises as desired.

Amplitude/High Level

Click or tap the **Ampl/HighL** button to set the parameter to "Ampl". "Ampl" is now highlighted. Click or tap its input field and use the pop-up numeric keypad to set the amplitude for noise. Available units for amplitude include Vpp, Vrms, and dBm (not available in HighZ) The amplitude for noise is 4 Vpp by default. The available range is related to the "Impedance" setting.

- HighZ: 2 mVpp to 4 Vpp.
- Load (50 Ω): 1 mVpp to 2 Vpp.

Click or tap the button again to toggle the parameter to "HighL". High Level = Offset + Amplitude/2. The high level range is related to the low level setting value. That is, high level minus low level cannot exceed the current range of amplitude.

Offset/Low Level

Click or tap the **Offset/LowL** button to set the parameter to "Offset". "Offset" is now highlighted. Click or tap its input field and use the pop-up numeric keypad to set the offset for noise. The range of offset is limited by the "Impedance" and "Amplitude/High Level" setting. The default offset is 0 Vdc.

Click or tap the button again to toggle the parameter to "LowL". Low Level = Offset - Amplitude/2. The low level range is related to the high level setting value. That is, high level minus low level cannot exceed the current range of amplitude.

TIP

The "Ampl" and "Offset" buttons appear at the same time, so are "HighL" and "LowL" buttons. For example, selecting "Offset" automatically toggles the "Ampl/HighL" parameter to "Ampl".

Channel Setup

You can also click or tap the "Channel" tab in *Continuous* interface to access the channel setup interface to configure channel output. For details, please refer to *Channel Setup*.



Enable the Channel Output

Refer to *Enable the Channel Output* of the "To Output Sine Wave" section.

5.6 To Output Arbitrary Waveforms

In the interface as shown in *Figure 5.1*, click or tap the "Wave Type" drop-down

button to select "Arb". You can also press the front-panel  to access the setting interface and create different Arb waveforms.

Arb Type

After "Arb" is selected, the Arb type is "Sinc" by default. You can click or tap the "Waveform Preview/Selection" area to select the Arb type in the displayed built-in waveform selection menu. You click or tap **Common**, **Engine**, **Seg Mod**, **Bioelect**, **Medical**, **Standard**, **Maths**, **Trigonome**, **Anti Trigonome**, and **Window Function** to select your desired Arb waveform. The selected waveform type is indicated in **Function** in the Arb setting interface.

Table 5.2 Built-in Waveforms

Name	Descriptions
Common	
DC	DC
Abs sine	Sine absolute value
Abs sine half	Half-sine absolute value
Amp alt	Gain oscillation curve
Att alt	Attenuation oscillation curve
Gauss pulse	Gaussian pulse
Neg ramp	Negative ramp
N pulse	Negative pulse
P pulse	Positive pulse
Sine tra	Sine-Tra waveform
Sine ver	Sine-Ver waveform
Stair Dn	Stair down
Stair Ud	Stair up/down
Stair Up	Stair up
Trapezia	Trapezia
Engineering	
Bandlimited	Band-limited signal
Blasei wav	Time-velocity curve
Butterworth	Butterworth filter
Chebyshev1	Type I Chebyshev filter
Chebyshev2	Type II Chebyshev filter

Name	Descriptions
Combin	Combination function
Cpulse	C-Pulse signal
Cw Pulse	CW pulse signal
Damped Osc	Damped oscillation time-offset curve
Dualtone	Dual-tone signal
Gamma	Gamma signal
Gatevibr	Gate self-excited oscillating signal
Lfm Pulse	Linear frequency modulation pulse signal
Mcnoise	Mechanical noise
Nimh Discharge	Discharge curve of NiMH batteries
Pahcur	DC brushless motor current waveform
Quake	Earthquake wave
Radar	Radar signal
Ripple	Power ripple
Roundhalf	Roundhalf waveform
Stepresp	Step response signal
Swing Osc	Swing oscillation kinetic energy-time curve
TV	TV signal
Voice	Voice signal
Segment Modulation	
Three Am	Sine piecewise AM waveform
Three Fm	Sine piecewise FM waveform
Three Pfm	Pulse piecewise FM waveform
Three Pm	Sine piecewise PM waveform
Three Pwm	Pulse width piecewise FM waveform
Bioelectricity	
Cardiac	Cardiac signal
Eog	Electro-oculogram (EOG)
Eeg	Electroencephalo-graph (EEG)
Emg	Electromyography (EMG)
Pulsilogram	Pulsilogram
Resspeed	Speed curve of the respiration
Medical	
Lf Pulse	Low frequency pulse electrotherapy waveform
Tens1	Transcutaneous Electric Nerve Stimulation (TENS) waveform 1
Tens2	Transcutaneous Electric Nerve Stimulation (TENS) waveform 2
Tens3	Transcutaneous Electric Nerve Stimulation (TENS) waveform 3
Standard	

Name	Descriptions
Ignition	Ignition waveform of the automotive motor
Iso16750 2 Sp	Automotive starting profile with ringing
Iso16750 2 Vr	Automotive supply voltage profile for resetting
Iso7637 2 Tp1	Automotive transients due to disconnects
Iso7637 2 Tp2a	Automotive transients due to inductance in wiring
Iso7637 2 Tp2b	Automotive transients due ignition switching off
Iso7637 2 Tp3a	Automotive transients due to switching
Iso7637 2 Tp3b	Automotive transients due to switching
Iso7637 2 Tp4	Automotive supply profile during starting
Iso7637 2 Tp5a	Automotive transients due to battery disconnect
Iso7637 2 Tp5b	Automotive transients due to battery disconnect
Scr	SCR firing profile
Surge	Surge signal
Maths	
Airy	Airy function
Besselj	Bessell function
Bessely	Besselll function
Cauchy	Cauchy distribution function
Cubic	Cubic function
Dirichlet	Dirichlet function
Erf	Error function
Erfc	Complementary error function
Erfcinv	Inverted complementary error function
Erfinv	Inverted error function
Expfall	Exponential fall function
Exprise	Exponential rise function
Gauss	Gaussian distribution (also known as normal distribution)
Haversine	HaverSine function
Laguerre	Quartic Laguerre polynomial
Laplace	Laplace distribution
Legend	Quintic Legendre polynomial
Log	Logarithmic function with the base of 10
Lognormal	Logarithmic normal distribution
Lorentz	Lorentz function
Maxwell	Maxwell distribution
Rayleigh	Rayleigh distribution
Versiera	Versiera

Name	Descriptions
Weibull	Weibull distribution
X2	Square function
Trigonome	
Cosh	Hyperbolic cosine
Cosint	Cosine integral
Cot	Cotangent function
Coth Con	Concave hyperbolic cotangent
Coth Pro	Protuberant hyperbolic cotangent
Csc Con	Concave cosecant
Csc Pro	Protuberant cosecant
Csch Con	Concave hyperbolic cosecant
Csch Pro	Protuberant hyperbolic cosecant
Recip Con	Concave reciprocal
Recip Pro	Protuberant reciprocal
Sec Con	Concave secant
Sec Pro	Protuberant secant
Sech	Hyperbolic secant
Sinc	Sinc function
Sinh	Hyperbolic sine
Sinint	Integral sine
Sqrt	Square root
Tan	Tangent
Tanh	Hyperbolic tangent
Anti Trigonome	
Acos	Arc cosine
Acosh	Arc hyperbolic cosine
Acot Con	Concave arc cotangent
Acot Pro	Protuberant arc cotangent
Acoth Con	Concave arc hyperbolic cotangent
Acoth Pro	Protuberant arc hyperbolic cotangent
Acsc Con	Concave arc cosecant
Acsc Pro	Protuberant arc cosecant
Acsch Con	Concave arc hyperbolic cosecant
Acsch Pro	Protuberant arc hyperbolic cosecant
Asec Con	Concave arc secant
Asec Pro	Protuberant arc secant
Asech	Arc hyperbolic secant
Asin	Arc Sinc
Asinh	Arc hyperbolic sine
Atan	Arc tangent
Atanh	Arc hyperbolic tangent

Name	Descriptions
Window Function	
Barlett	Bartlett window
Barthannwin	Modified Bartlett window
Blackman	Blackman window
Blackman H	BlackmanH window
Bohmanwin	Bohman window
Boxcar	Rectangle window
Chebwin	Chebyshev window
Flattopwin	Flat-top window
Hamming	Hamming window
Hanning	Hanning window
Kaiser	Kaiser window
Nuttallwin	Nuttall-defined minimum 4-term Blackman-Harris window
Parzenwin	Parzen window
Taylorwin	Taylor window
Triang	Triangle window (also Fejer window)
Tukeywin	Tukey window

Set Arb Parameters

After selecting the waveform (except DC), you can set the frequency/period, amplitude/high level, offset/low level, and phase. To set the waveform parameters and output, please refer to [To Output Sine Wave](#).

When the Arb type is set to DC, only offset setting is available. The range of DC offset is related to the "Impedance" setting.

- HighZ: -10 Vdc to +10 Vdc.
- Load (50 Ω): -5 Vdc to +5 Vdc.

5.7 To Output Harmonic

DG800 Pro can be used as a harmonic generator to output harmonics with the specified order, amplitude, and phase. It is usually used in the test of harmonic detector device or harmonic filter device. According to Fourier transform, time domain waveform is the superposition of a series of sine waveforms as shown in the equation below:

$$f(t) = A_1 \sin(2\pi f_1 t + \varphi_1) + A_2 \sin(2\pi f_2 t + \varphi_2) + A_3 \sin(2\pi f_3 t + \varphi_3) + \dots$$

Generally, the component with f_1 frequency is called the fundamental waveform, with f_1 as the fundamental frequency, A_1 as the fundamental amplitude, and φ_1 as the

fundamental phase. The frequencies of the other components (called harmonics) are all integral multiples of the fundamental frequency.

In the interface as shown in [Figure 5.1](#), click or tap the "Wave Type" drop-down button to select "Harmonic". You can also click or tap the "Waveform Preview/Selection" area and then select **Harmonic** in the displayed built-in waveform selection menu to enter the setting interface for Harmonic, as shown in the figure below.

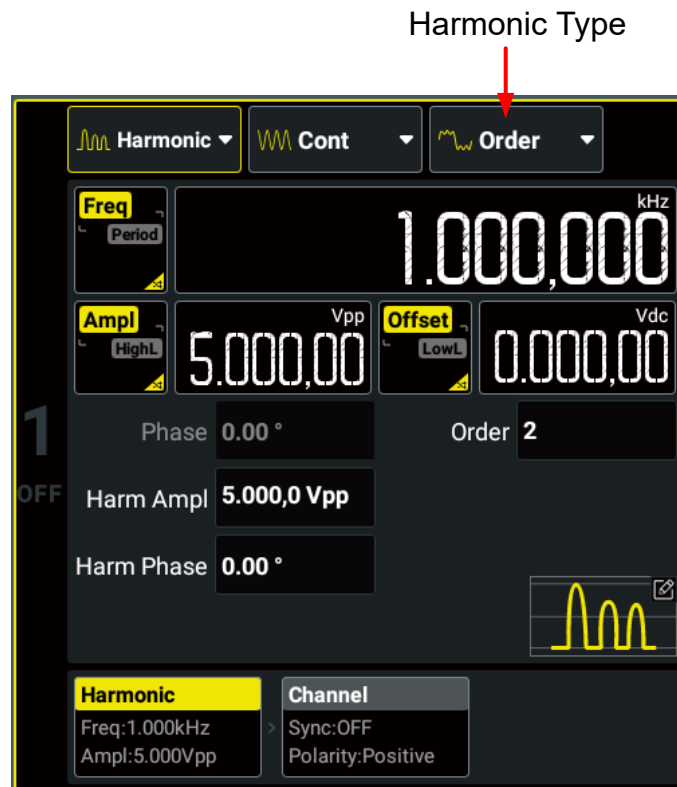

Figure 5.2 Harmonic Setting Interface

Fundamental Waveform Parameters

DG800 Pro allows you to set the frequency/period, amplitude/high level, offset/low level, and starting phase for fundamental waveforms. You can refer to [To Output Sine Wave](#) to set the above parameters. Note that V_{rms} and dBm are not available for the unit of the fundamental amplitude.

TIP

The max. fundamental frequency (F_{fund}) is limited by the harmonic order (N) and max. harmonic frequency (F_{max}): $F_{fund} = (2 \times F_{max} \div N)$. Changing the harmonic order may modify the fundamental frequency. For the max. harmonic frequency (F_{max}) of different models, refer to [Table 5.1 Range of Continuous Waveform Frequency](#).

Harmonic Type

Click or tap the "Harmonic Type" drop-down button to select the desired type.

- **Order:** only outputs the basic waveform and the specified harmonic component. For example, if the **Order** is set to 5, the instrument will output the basic waveform and the 5th harmonic component.

- **Combine:** outputs harmonics with multiple harmonic components.

In this mode, 20 bits binary data are used to represent the output status of the 20 orders of harmonics respectively; wherein, 1 represents enabling the output of the corresponding harmonic and 0 represents disabling the output of the corresponding harmonic. Click or tap the **User** input field and use the pop-up virtual keypad to set the value of each data bit. Note that the leftmost bit representing fundamental waveform is always X and can not be modified. For example, set the 20 bits data to X001 0000 0000 0000 0001 and then fundamental waveform as well as 4th and 20th orders of harmonics will be output.

Order Harmonic

Click or tap the "Harmonic Type" drop-down button to select "Order" to enter the setting menu. Click or tap the **Order** input field to set the order. It ranges from 2 (default) to 20. After that, you can set the harmonic amplitude and phase.

- **Harmonic Amplitude:** click or tap the **Harm Ampl** input field to set the amplitude with the pop-up virtual keypad.
- **Harmonic Phase:** click or tap the **Harm Phase** input field to set the phase with the pop-up virtual keypad.

Combine Harmonic

Click or tap the "Harmonic Type" drop-down button to select "Combine" to enter the setting menu. Click or tap the **User** input field to set the user-defined orders of harmonics. After that, you can click or tap the harmonic editing table to set the amplitude and phase in the pop-up menu.

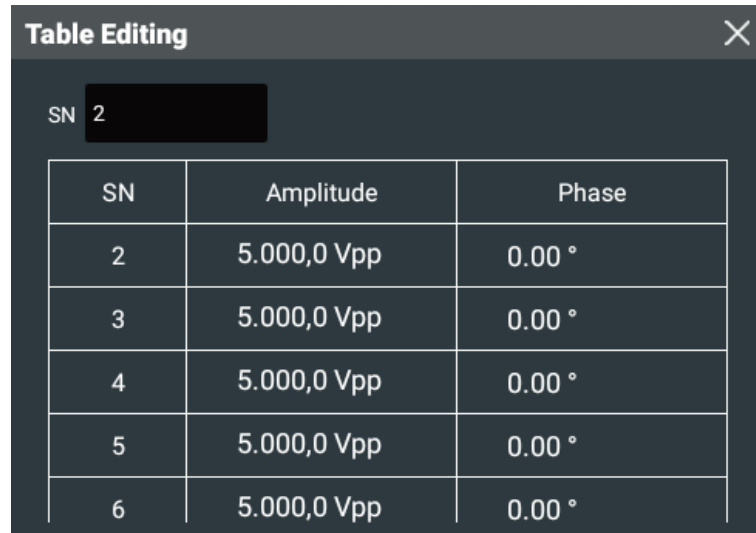

SN	Amplitude	Phase
2	5.000,0 Vpp	0.00 °
3	5.000,0 Vpp	0.00 °
4	5.000,0 Vpp	0.00 °
5	5.000,0 Vpp	0.00 °
6	5.000,0 Vpp	0.00 °

Figure 5.3 Table Editing Menu

- **Harmonic Amplitude:** click or tap any cell in the **Amplitude** column and use the pop-up virtual keypad to set the amplitude for the harmonic with the specified order.
- **Harmonic Phase:** click or tap any cell in the **Phase** column and use the pop-up virtual keypad to set the phase for the harmonic with the specified order.



TIP

You can click or tap the **SN** input field to set the order to locate the specified harmonic quickly.

Channel Setup

You can also click or tap the "Channel" tab in *Continuous* interface to access the channel setup interface to configure channel output. For details, please refer to *Channel Setup*.

Enable the Channel Output

Refer to *Enable the Channel Output* of the "To Output Sine Wave" section.

6 Modulation

DG800 Pro allows you to output various modulated waveforms. Available modulation types include AM, FM, PM, ASK, FSK, PSK, PWM, and SUM. Both internal and external modulation sources are available for modulating waveforms.

Click or tap the "Output Mode" drop-down button to select "Mod" and access the interface as shown in the figure below. You can click or tap one of the tabs at the bottom to access the Continuous (Carrier) Setting Interface, Modulation Setting Interface, or Channel Setup Interface. For Continuous (Carrier) Setting Interface and Channel Setup Interface, please refer to *Continuous* and *Channel Setup* respectively. This chapter only describes the modulation settings.

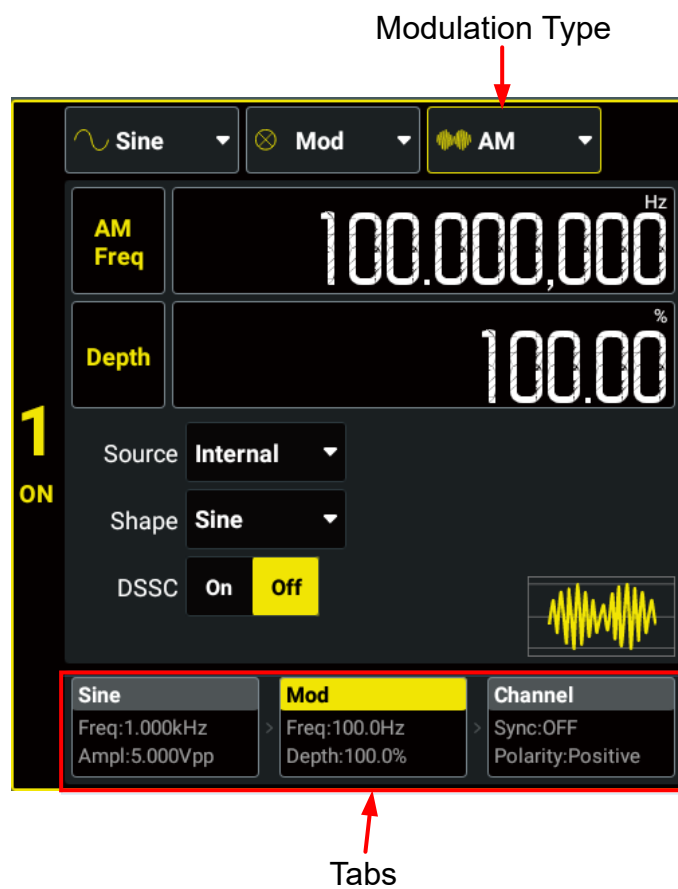

Figure 6.1 Modulation Setting Interface

6.1 Amplitude Modulation (AM)

In Amplitude Modulation (AM), a modulated waveform consists of a carrier waveform and a modulating waveform. The amplitude of the carrier waveform is varied by the instantaneous voltage of the modulating waveform. In the "Modulation Setting

Interface" (*Figure 6.1*), click or tap the "Modulation Type" drop-down button to select "AM" and set its parameters.

Carrier Waveform

Available AM carrier waves include sine (default), square, ramp, and Arb (except DC). Click or tap the "Wave Type" drop-down button or press the corresponding front-panel waveform selection key to select the desired carrier waveform shape. Enter the carrier setting interface and refer to *Continuous* to set the carrier parameters.

Modulating Waveform

The instrument accepts an internal or external signal as the modulation source. Click or tap the **Source** drop-down button to select "Internal" or "External".

- **Internal Source**

After "Internal" is selected, you can click or tap the **Shape** drop-down button to select the modulating waveform shape. Available shapes include:

- Sine
- Square with 50% duty cycle
- Triangle with 50% symmetry
- UpRamp with 100% symmetry
- DnRamp with 0% symmetry
- Noise - white gaussian noise
- Arb - standard arbitrary waveform other than DC. The Arb cannot be selected as the shape of the carrier waveform and internal modulating waveform at the same time.

- **External Source**

After "External" is selected, **Shape** and **AM Freq** are grayed out and disabled. The instrument accepts an external modulation source applied to the rear-panel **[AUX IN/OUT]** connector. At this time, the amplitude of the modulated waveform is controlled by the ± 5 V signal level present on the connector.

NOTE

How to realize the intermodulation between dual channels? The following example takes the output signal of CH2 as the modulating waveform.

1. Connect the CH2 output terminal to the rear-panel **[AUX IN/OUT]** connector of CH1 using the dual BNC cable.
2. Select CH1 and set the output mode to "Mod". Select the desired modulation type and set the corresponding parameters. Set the **Source** to "External".
3. Select CH2 and set the desired shape as well as the corresponding parameters.



4. Turn on the CH1 and CH2 outputs.

Modulation Frequency

After the internal modulation source is selected, click or tap the **AM Freq** input field and set the modulation frequency with the pop-up numeric keypad. The available range is from 2 mHz to 1 MHz, and the default is 100 Hz. The resolution is 1 μ Hz.

TIP

When an external modulation source is selected, this setting is grayed out and disabled.

Modulation Depth

Modulation depth is a percentage that represents the amplitude variation. Click or tap the **Depth** input field to set the modulation depth. AM depth ranges from 0% to 120%. The default is 100%, and the resolution is 0.01%.

- At 0% depth, the amplitude is one-half of the carrier's amplitude setting.
- At 100% depth, the amplitude is identical to the carrier's amplitude setting.
- At greater than 100% depth, the output amplitude will not exceed the maximum output amplitude .

When an external modulation source is selected, the AM modulation amplitude is also controlled by the ± 5 V signal level on the rear-panel **[AUX IN/OUT]** connector. For example, if the modulation depth is set to 100%, then the output will be at the maximum amplitude when the modulating signal is at +5 V. The output will be at the minimum amplitude when the modulating signal is at -5 V.

DSSC

DG800 Pro supports two forms of amplitude modulation, Normal and Double Sideband Suppressed Carrier (DSSC). In "normal" AM, the modulated wave consists of the carrier wave and two sidebands. Such a modulation is inefficient because the carrier wave carries no information. If this carrier is suppressed and the saved power is distributed to the two sidebands, then such a process is called Double Sideband Suppressed Carrier (DSSC).

By default, the "DSSC" is off. Click or tap the **DSSC** on/off switch to turn on or off the DSSC function.

6.2 Frequency Modulation (FM)

In Frequency Modulation (FM), a modulated waveform consists of a carrier waveform and a modulating waveform. The frequency of the carrier waveform is varied by the instantaneous voltage of the modulating waveform. In the "Modulation Setting Interface" (*Figure 6.1*), click or tap the "Modulation Type" drop-down button to select "FM" and set its parameters.

Carrier Waveform

Available FM carrier waves include sine (default), square, ramp, and Arb (except DC). Click or tap the "Wave Type" drop-down button or press the corresponding front-panel waveform selection key to select the desired carrier waveform shape. Enter the carrier setting interface and refer to *Continuous* to set the carrier parameters.

Modulating Waveform

The instrument accepts an internal or external signal as the modulation source. Click or tap the **Source** drop-down button to select "Internal" or "External".

- **Internal Source**

After "Internal" is selected, you can click or tap the **Shape** drop-down button to select the modulating waveform shape. Available shapes include:

- Sine
- Square with 50% duty cycle
- Triangle with 50% symmetry
- UpRamp with 100% symmetry
- DnRamp with 0% symmetry
- Noise - white gaussian noise
- Arb - standard arbitrary waveform other than DC. The Arb cannot be selected as the shape of the carrier waveform and internal modulating waveform at the same time.

- **External Source**

After "External" is selected, **Shape** and **FM Freq** are grayed out and disabled. The instrument accepts an external modulation source applied to the rear-panel **[AUX IN/OUT]** connector. At this time, the amplitude of the modulated waveform is controlled by the ± 5 V signal level present on the connector.

Modulation Frequency

After the internal modulation source is selected, click or tap the **FM Freq** input field and set the modulation frequency with the pop-up numeric keypad. The available range is from 2 mHz to 1 MHz, and the default is 100 Hz. The resolution is 1 μ Hz.

TIP

When an external modulation source is selected, this setting is grayed out and disabled.



Frequency Deviation

It represents the peak variation in frequency of the modulated waveform from the carrier frequency. Click or tap the **Freq Dev** input field to set the frequency deviation. The minimum frequency deviation is 0 Hz.

- For FM, the frequency deviation must always be less than or equal to the carrier frequency minus 1 μ Hz.
- The frequency deviation plus the carrier frequency must be less than or equal to the selected carrier's maximum frequency.

When an external modulation source is selected, the frequency deviation is controlled by the ± 5 V signal level on the rear-panel **[AUX IN/OUT]** connector. For example, if the frequency deviation is set to 1 kHz, the +5 V signal level corresponds to a 1 kHz increase in frequency. Lower external signal levels produce less deviation and negative signal levels reduce the frequency below the carrier frequency.

6.3 Phase Modulation (PM)

In Phase Modulation (PM), a modulated waveform consists of a carrier waveform and a modulating waveform. The phase of the carrier waveform is varied by the instantaneous voltage of the modulating waveform. In the "Modulation Setting Interface" (*Figure 6.1*), click or tap the "Modulation Type" drop-down button to select "PM" and set its parameters.

Carrier Waveform

Available PM carrier waves include sine (default), square, ramp, and Arb (except DC). Click or tap the "Wave Type" drop-down button or press the corresponding front-panel waveform selection key to select the desired carrier waveform shape and access the setup interface. To configure different carrier waveforms, please refer to *Continuous*.

Modulating Waveform

The instrument accepts an internal or external signal as the modulation source. Click or tap the **Source** drop-down button to select "Internal" or "External".

- **Internal Source**

After "Internal" is selected, you can click or tap the **Shape** drop-down button to select the modulating waveform shape. Available shapes include:

- Sine
- Square with 50% duty cycle
- Triangle with 50% symmetry
- UpRamp with 100% symmetry

- DnRamp with 0% symmetry
 - Noise - white gaussian noise
 - Arb - standard arbitrary waveform other than DC. The Arb cannot be selected as the shape of the carrier waveform and internal modulating waveform at the same time.
- **External Source**
After "External" is selected, **Shape** and **PM Freq** are grayed out and disabled. The instrument accepts an external modulation source applied to the rear-panel **[AUX IN/OUT]** connector. At this time, the amplitude of the modulated waveform is controlled by the ± 5 V signal level present on the connector.

Modulation Frequency

After the internal modulation source is selected, click or tap the **PM Freq** input field and set the modulation frequency with the pop-up numeric keypad. The available range is from 2 mHz to 1 MHz, and the default is 100 Hz. The resolution is 1 μ Hz.

TIP

When an external modulation source is selected, this setting is grayed out and disabled.

Phase Deviation

The phase deviation represents the peak variation in phase of the modulated waveform from the carrier waveform. Click or tap the **PM Dev** input field to set the phase deviation. It ranges from 0° to 360°, and the default is 90°. The resolution is 0.01°.

When an external modulation source is selected, the phase deviation is controlled by the ± 5 V signal level on the rear-panel **[AUX IN/OUT]** connector. For example, if the phase deviation is set to 180°, the +5 V signal level corresponds to a 180° phase shift. Lower external signal levels produce less deviation.

6.4 Amplitude Shift Keying (ASK)

With Amplitude Shift Keying (ASK), you can configure the instrument to "shift" its output amplitude between two preset values (called the "carrier amplitude" and the "modulation amplitude"). In the "Modulation Setting Interface" ([Figure 6.1](#)), click or tap the "Modulation Type" drop-down button to select "ASK" and set its parameters.

Carrier Waveform

Available ASK carrier waves include sine (default), square, ramp, and Arb (except DC). Click or tap the "Wave Type" drop-down button or press the corresponding front-panel waveform selection key to select the desired carrier waveform shape.

In the Carrier (Continuous) interface, click or tap the **Ampl/HighL** button to set the parameter to "Ampl". Click or tap its input field and use the pop-up numeric keypad to set the carrier amplitude. For carrier amplitude setting methods and available range, please refer to *Continuous*.

Modulation Source

The instrument accepts an internal or external signal as the modulation source. Click or tap the **Source** drop-down button to select "Internal" or "External".

- **Internal Source**

When "Internal" is selected, the instrument uses a square wave with 50% duty cycle as the ASK modulation source. At this time, the output amplitude "shifts" between "carrier amplitude" and "modulation amplitude". The shift rate is determined by "ASK Rate".

- **External Source**

When "External" is selected, the generator receives the external modulating signal from the rear-panel **[AUX IN/OUT]** connector.

ASK Rate

ASK rate is the rate at which the output amplitude "shifts" between the carrier amplitude and modulation amplitude when an internal modulation source is used. Click or tap the **ASK Rate** input field and use the pop-up numeric keypad to set the rate. The available range is from 2 mHz to 1 MHz, and the default is 100 Hz. The resolution is 1 μ Hz.

TIP

When the external modulation source is selected, this setting is grayed out and disabled.

Modulation Amplitude

Click or tap the **ASK Ampl** input field and use the pop-up numeric keypad to set the modulation amplitude. The available range of modulation amplitude is consistent with the range of basic waveform amplitude and the default is 2 Vpp.

Polarity

Click or tap the **Polarity** drop-down button to select "Positive" or "Negative" to control the amplitude output. The default is "Positive".

- **Positive:** when the internal/external modulation signal is a logic low level, the carrier amplitude is output; when the signal is a logic high level, the modulation amplitude is output.
- **Negative:** when the internal/external modulation signal is a logic low level, the modulation amplitude is output; when the signal is a logic high level, the carrier amplitude is output.



6.5 Frequency Shift Keying (FSK)

With Frequency Shift Keying (FSK), you can configure the instrument to "shift" its output frequency between two preset values (called the "carrier frequency" and the "hop frequency"). In the "Modulation Setting Interface" ([Figure 6.1](#)), click or tap the "Modulation Type" drop-down button to select "FSK" and set its parameters.

Carrier Waveform

Available FSK carrier waves include sine (default), square, ramp, and Arb (except DC). Click or tap the "Wave Type" drop-down button or press the corresponding front-panel waveform selection key to select the desired carrier waveform shape.

In the Carrier (Continuous) interface, click or tap the **Freq/Period** button to set the parameter to "Freq". Click or tap its input field and use the pop-up numeric keypad to set the carrier frequency. The frequency range varies for different carrier waveforms. For details, refer to [Continuous](#).

Modulation Source

The instrument accepts an internal or external signal as the modulation source. Click or tap the **Source** drop-down button to select "Internal" or "External".

- **Internal Source**

When "Internal" is selected, the instrument uses a square wave with 50% duty cycle as the FSK modulation source. At this time, the output frequency "shifts" between "carrier frequency" and "hop frequency". The shift rate is determined by "FSK Rate" .

- **External Source**

When "External" is selected, the generator receives the external modulating signal from the rear-panel **[AUX IN/OUT]** connector.

FSK Rate

FSK rate is the rate at which the output frequency "shifts" between the carrier frequency and the hop frequency when an internal modulation source is used. Click or tap the **FSK Rate** input field and use the pop-up numeric keypad to set the rate. The available range is from 2 mHz to 1 MHz, and the default is 100 Hz.

TIP

When the external modulation source is selected, this setting is grayed out and disabled.



Hop Frequency

Click or tap the **Hop Freq** input field and use the pop-up numeric keypad to set the hop frequency. The range of hop frequency is related to the instrument model and wave type. For details, refer to [Table 5.1 Range of Continuous Waveform Frequency](#) .

Polarity

Click or tap the **Polarity** drop-down button to select "Positive" or "Negative" to control the frequency output. The default is "Positive".

- **Positive:** when the internal/external modulation signal is a logic low level, the carrier frequency is output; when the signal is a logic high level, the hop frequency is output.
- **Negative:** when the internal/external modulation signal is a logic low level, the hop frequency is output; when the signal is a logic high level, the carrier frequency is output.

6.6 Phase Shift Keying (PSK)

In Phase Shift Keying (PSK), you can configure the instrument to "shift" its output phase between two preset phase settings ("carrier phase" and "modulation phase"). In the "Modulation Setting Interface" (*Figure 6.1*), click or tap the "Modulation Type" drop-down button to select "PSK" and set its parameters.

Carrier Waveform

Available PSK carrier waves include sine (default), square, ramp, and Arb (except DC). Click or tap the "Wave Type" drop-down button or press the corresponding front-panel waveform selection key to select the desired carrier waveform shape.

In the Carrier (Continuous) interface, click or tap the "Phase" input field and use the pop-up numeric keypad to set the starting phase. It ranges from -360° to 360° , and the default is 0° . The resolution is 0.01° .

Modulation Source

The instrument accepts an internal or external signal as the modulation source. Click or tap the **Source** drop-down button to select "Internal" or "External".

- **Internal Source**

When "Internal" is selected, the instrument uses a square wave with 50% duty cycle as the PSK modulation source. At this time, the output phase "shifts" between "carrier phase" and "modulation phase". The shift rate is determined by "PSK Rate".

- **External Source**

When "External" is selected, the generator receives the external modulating signal from the rear-panel **[AUX IN/OUT]** connector.

PSK Rate

PSK rate is the rate at which the output phase "shifts" between the carrier phase and modulation phase when an internal modulation source is used. Click or tap the **PSK**

Rate input field and use the pop-up numeric keypad to set the rate. The available range is from 2 mHz to 1 MHz, and the default is 100 Hz. The resolution is 1 μ Hz.



TIP

When the external modulation source is selected, this setting is grayed out and disabled.

Modulation Phase

Click or tap the **Phase** input field and use the pop-up numeric keypad to set the modulation phase. It ranges from 0° to 360°, and the default is 180°. The resolution is 0.01°.

Polarity

Click or tap the **Polarity** drop-down button to select "Positive" or "Negative" to control the phase output. The default is "Positive".

- **Positive:** when the internal/external modulation signal is a logic low level, the carrier phase is output; when the signal is a logic high level, the modulation phase is output.
- **Negative:** when the internal/external modulation signal is a logic low level, the modulation phase is output; when the signal is a logic high level, the carrier phase is output.

6.7 Pulse Width Modulation (PWM)

For Pulse Width Modulation (PWM), the pulse width of the output signal is varied by the instantaneous voltage of the modulating waveform. The amount by which the pulse width varies is called the width deviation.



TIP

To select the PWM function, first click or tap the "Wave Type" drop-down button to select "Pulse" and then set the "Output Mode" to "Mod". The modulation type will be set to "PWM" automatically. Refer to the following section to set the other modulation parameters.

Carrier Waveform

PWM is only available for the Pulse waveform. Click or tap the "Wave Type" drop-down button to select "Pulse" or press the front-panel  key to set the carrier waveform to Pulse.

For pulse width/duty cycle setting, refer to *To Output Pulse*.

Modulation Source

The instrument accepts an internal or external signal as the modulation source. Click or tap the **Source** drop-down button to select "Internal" or "External".

- **Internal Source**

After "Internal" is selected, you can click or tap the **Shape** drop-down button to select the modulating waveform shape. Available shapes include:

- Sine
- Square with 50% duty cycle
- Triangle with 50% symmetry
- UpRamp with 100% symmetry
- DnRamp with 0% symmetry
- Noise - white gaussian noise
- Arb - standard arbitrary waveform other than DC

- **External Source**

After "External" is selected, **Shape** and **PWM Freq** are grayed out and disabled. The instrument accepts an external modulation source applied to the rear-panel **[AUX IN/OUT]** connector. At this time, the amplitude of the modulated waveform is controlled by the ± 5 V signal level present on the connector.

Modulation Frequency

After the internal modulation source is selected, click or tap the **PWM Freq** input field and set the modulation frequency with the pop-up numeric keypad. The available range is from 2 mHz to 1 MHz, and the default is 100 Hz.

TIP

When an external modulation source is selected, this setting is disabled.

Width/Duty Cycle Deviation

PWM deviation represents the variation of the modulated waveform pulse width relative to the original pulse width. You can use time (width deviation) or duty cycle (duty cycle deviation) to set the PWM deviation. This setting is subject to the *Pulse Width/Duty Cycle* setting in Carrier (Pulse) setting. For example, if "Width" is selected for *Pulse Width/Duty Cycle* of the Pulse setting, then the PWM deviation setting is automatically set to "Width Dev".

- **Width Deviation**

Width deviation represents the amount by which the pulse width of the modulated waveform varies from the original pulse width. The unit is s. For example, if you specify a pulse width as 10 s and width deviation as 5 s, the pulse width of the modulated waveform varies from 5 s to 15 s under the control of the modulating signal.

Click or tap the **Duty Dev/Width Dev** button to set the parameter to "Width Dev". "Width Dev" is now highlighted. Click or tap its input field to set the width deviation. The range of the width deviation is limited by the pulse width, pulse period, and leading/trailing edge of the pulse waveform:

- $\text{Width Deviation} \leq \text{Pulse Width} - 5.25 \text{ ns} - (\text{Leading Edge Time} + \text{Trailing Edge Time})/1.6.$
- $\text{Width Deviation} \leq \text{Pulse Period} - \text{Pulse Width} - 5.25 \text{ ns} - (\text{Leading Edge Time} + \text{Trailing Edge Time})/1.6.$
- **Duty Cycle Deviation**

Duty cycle deviation represents the amount by which the pulse width of the modulated waveform varies from the original pulse width. The unit is the percentage of the waveform period. For example, if you specify a pulse duty cycle as 10% and duty cycle deviation as 5%, the duty cycle of the modulated waveform varies from 5% to 15% under the control of the modulating signal.

Click or tap the **Duty Dev/Width Dev** button to set the parameter to "Duty Dev". "Duty Dev" is now highlighted. Click or tap its input field to set the duty cycle deviation. The duty cycle deviation ranges from 0% to 49.99%, and is limited by the pulse duty cycle and period limits.

When an external modulation source is selected, the width deviation (or duty cycle deviation) is controlled by the $\pm 5 \text{ V}$ signal level on the rear-panel **[AUX IN/OUT]** connector. For example, if the width deviation is set to 10 s, the +5 V signal level corresponds to a 10 s deviation.

6.8 SUM Modulation

When the waveform summing function is enabled, you can add a specified waveform to the current basic/Arb waveform. In the "Modulation Setting Interface" ([Figure 6.1](#)), click or tap the "Modulation Type" drop-down button to select "SUM" and set its parameters.

Carrier Waveform

Available carrier waves include sine (default), square, ramp, and Arb (except DC). Click or tap the "Wave Type" drop-down button or press the corresponding front-panel waveform selection key to select the desired carrier waveform shape. Enter the carrier setting interface and refer to [Continuous](#) to set the carrier parameters.

Sum Source

Click or tap the **Waveform** drop-down button to select the waveform to be added to the current waveform. Available waveform shapes include:

- Sine

- Square with 50% duty cycle
- Ramp with 50% symmetry
- Noise - white gaussian noise
- Arb - standard arbitrary waveform other than DC
- CH1/CH2: the waveform from the other channel

Sum Frequency

It sets the frequency of the waveform to be added to the current continuous waveform. Click or tap the **SUM Freq** input field and use the pop-up virtual keypad to set the frequency. The range of the Sum frequency is from 2 mHz to 1 MHz.

Sum Ratio

It sets the ratio of the amplitude of the waveform to be added relative to the amplitude of the current waveform. Click or tap the **SUM Ratio** input field and use the pop-up virtual keypad to set the ratio. The default value is 50%. The available range is limited by the current carrier amplitude and max. amplitude.

7 Sweep

In frequency sweep mode, the instrument moves from the start frequency to the stop frequency within a specified sweep time. You can sweep up or down in frequency, with linear, logarithmic, or step sweep types. It allows you to set the "Mark" frequency, start/stop hold time, and return time. It provides trigger sources including internal, external, and manual sources. You can sweep sine, square, ramp, and Arb (except DC).

Click or tap the "Output Mode" drop-down button to select "Sweep" and access the interface as shown in the figure below. You can click or tap one of the tabs at the bottom to access the Continuous Setting Interface, Sweep Setting Interface, or Channel Setup Interface. For Continuous Setting Interface and Channel Setup Interface, please refer to *Continuous* and *Channel Setup* respectively. This chapter only describes the sweep settings.

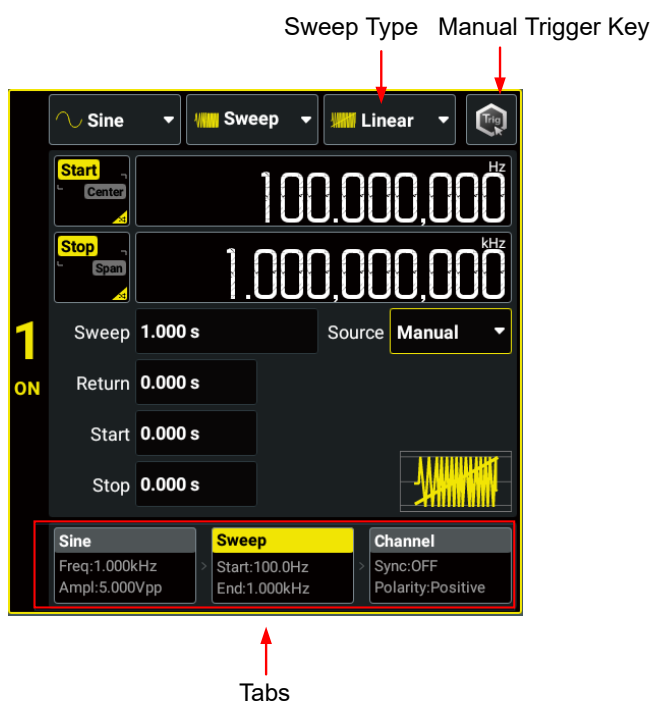

Figure 7.1 Sweep Setting Interface

7.1 Sweep Type

DG800 Pro provides three sweep types: Linear, Log, and Step. The default is Linear. Click or tap the "Sweep Type" drop-down button to can select "Linear", "Log", or "Step".

Linear Sweep

The instrument varies the output frequency linearly during the sweep, changing the output frequency by a constant number of Hz per second. It is characterized by "Start Frequency", "Stop Frequency", and "Sweep Time".

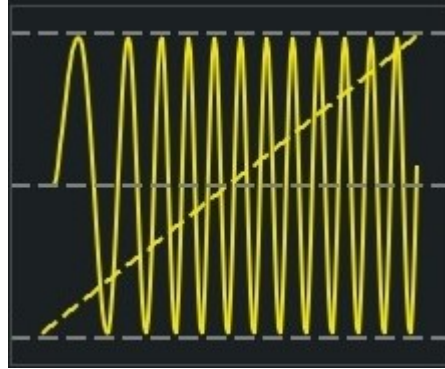

Figure 7.2 Linear Sweep

Logarithmic Sweep

The instrument varies the output frequency logarithmically during the sweep, changing the frequency by a constant number of octaves. It is characterized by "Start Frequency", "Stop Frequency", and "Sweep Time".

Define the start frequency, stop frequency, sweep time as F_{start} , F_{stop} , and T_{sweep} . The function of logarithmic sweep is $F = P^t$; wherein, P and T can be expressed in the following equations:

$$P = 10^{\lg(F_{stop}/F_{start})/T_{sweep}}$$

$$T = t + \lg(F_{start})/\lg(P)$$

In the equations above, t is the duration time after the sweep starts, ranging from 0 to T_{sweep} ; F is the current instantaneous frequency.

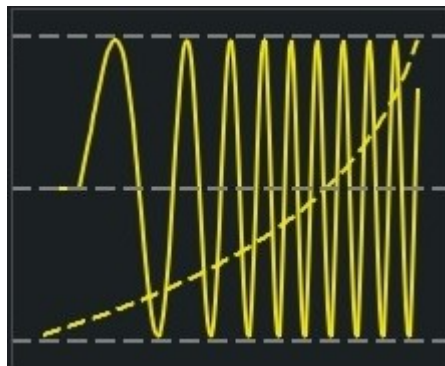

Figure 7.3 Logarithmic Sweep

Step Sweep

The instrument "steps" through a list of frequencies during the sweep. The period that the output signal dwells on each frequency is determined by "Sweep Time" and "Step Number".

When the sweep type is set to "Step", click or tap the **Step Num** input field to set the number of steps. It ranges from 2 (default) to 1024.

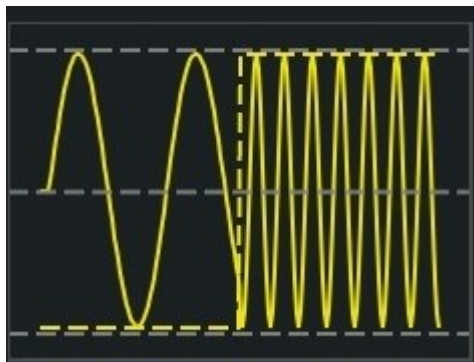

Figure 7.4 Step Sweep

7.2 Start Frequency and Stop Frequency

The start frequency and stop frequency set the sweep's upper and lower frequency bounds. The sweep begins at the start frequency, sweeps to the stop frequency, and then resets back to the start frequency.

- To sweep up in frequency, set the start frequency less than the stop frequency.
- To sweep down in frequency, set the opposite relationship.
- To sweep in a fixed frequency, set the same start frequency and stop frequency.

After enabling the sweep mode, click or tap the **Start/Center** button to set the parameter to "Start". "Start" is now highlighted. This operation also toggles the parameter of the **Stop/Span** button to "Stop". Click or tap the corresponding input field and use the pop-up numeric keypad to set the start frequency and stop frequency. By default, the start frequency is 100 Hz and the stop frequency is 1 kHz. The range of start/stop frequency is related to the instrument model and wave type. For details, refer to [Table 5.1 Range of Continuous Waveform Frequency](#).

After the start/stop frequency is modified, the instrument will sweep from the specified start frequency again.

7.3 Center Frequency and Frequency Span

You can also set the sweep frequency boundaries of the sweep using a center frequency and frequency span.

- Center Frequency = (Start Frequency + Stop Frequency)/2
- Frequency Span = Stop Frequency - Start Frequency

After enabling the sweep mode, click or tap the **Start/Center** button to set the parameter to "Center". "Center" is now highlighted. This operation also toggles the parameter of the **Stop/Span** button to "Span". Click or tap the corresponding input field and use the pop-up numeric keypad to set the center frequency or frequency span. By default, the center frequency is 550 Hz and the frequency span is 900 Hz. The ranges of center frequency and frequency span vary for different waveforms. Also, they are limited to each other.

The range of frequency span is affected by the center frequency. Define the upper limit of the start/stop frequency as F_{\max} and the lower limit of the start/stop frequency as F_{\min} (*Table 5.1 Range of Continuous Waveform Frequency*). $F_m = (F_{\max} - F_{\min})/2$.

- When Center Frequency $\leq F_m$, the Frequency Span is $\pm 2 \times (\text{Center Frequency} - F_{\min})$.
- When Center Frequency $> F_m$, the Frequency Span is $\pm 2 \times (F_{\max} - \text{Center Frequency})$.

Take sine wave as an example. F_{\min} is 1 μHz , F_{\max} is 50 MHz, and F_m is 25 MHz. If the center frequency is 5 MHz, the frequency span range is $\pm 2 \times (5 \text{ MHz} - 1 \mu\text{Hz}) = \pm 10 \text{ MHz}$; if the center frequency is 30 MHz, the frequency span range is $\pm 2 \times (50 \text{ MHz} - 30 \text{ MHz}) = \pm 40 \text{ MHz}$.

TIP

To sweep up in frequency, set a positive frequency span; to sweep down, set a negative frequency span.



7.4 Sweep Time

Sweep time specifies the time required to sweep from the start frequency to the stop frequency.

Click or tap the **Sweep** input field and use the pop-up numeric keypad to set the sweep time. The default sweep time is 1 s and the resolution is 1 ms. The sweep time ranges from 1 ms to 250,000 s. The sweep time is related to the sweep type, trigger source, start hold time, return time, and stop hold time. $T_p = \text{Sweep Time} + \text{Start Hold Time} + \text{Return Time} + \text{Stop Hold Time}$:

- **Linear Sweep:**
 - Internal trigger: $T_p + 1 \text{ ms} \leq 8,000 \text{ s}$
 - Manual trigger/external trigger: $T_p \leq 250,000 \text{ s}$

- **Log Sweep/Step Sweep:** $T_p \leq 500$ s

After the sweep time is modified, the instrument will sweep from the specified "Start Frequency" again.

7.5 Start/Stop Hold Time

Start hold time specifies the time for the sweep to remain at the "Start Frequency". After the start hold time expires, the generator continues to sweep at varied frequencies according to the current sweep type.

Stop hold time specifies the time for the sweep to remain at the "Stop Frequency" after the generator sweeps from the "Start Frequency" to the "Stop Frequency".

You can click or tap the **Start/Stop** input field and use the pop-up numeric keypad to set the start/stop hold time. The default start/stop hold time is 0 s and the resolution is 1 ms. The time ranges from 0 s to 3600 s and is related to the sweep type, trigger source, return time, and sweep time. $T_p = \text{Sweep Time} + \text{Start Hold Time} + \text{Return Time} + \text{Stop Hold Time}$:

- **Linear Sweep:**
 - Internal trigger: $T_p + 1$ ms $\leq 8,000$ s
 - Manual trigger/external trigger: $T_p \leq 250,000$ s
- **Log Sweep/Step Sweep:** $T_p \leq 500$ s

After the start/stop hold time is modified, the instrument will sweep from the specified start frequency again.

7.6 Return Time

Return time specifies the time to return from the "Stop Frequency" to the "Start Frequency".



Click or tap the **Return** input field and use the pop-up numeric keypad to set the return time. The default return time is 0 s and the resolution is 1 ms. The time ranges from 0 s to 3600 s and is related to the sweep type, trigger source, start hold time, stop hold time, and sweep time. $T_p = \text{Sweep Time} + \text{Start Hold Time} + \text{Return Time} + \text{Stop Hold Time}$:

- **Linear Sweep:**
 - Internal trigger: $T_p + 1$ ms $\leq 8,000$ s
 - Manual trigger/external trigger: $T_p \leq 250,000$ s
- **Log Sweep/Step Sweep:** $T_p \leq 500$ s

After the return time is modified, the instrument will sweep from the specified "Start Frequency" again.

7.7 Sweep Trigger Source

The sweep trigger source can be internal trigger, external leading edge, external trailing edge, or manual trigger. The instrument outputs a single sweep when a trigger signal is received and waits for the next trigger. Click or tap the **Source** drop-down button and select the trigger source. The default is "Internal".

- **Internal:** The instrument outputs a continuous sweep. The trigger period is determined by the specified sweep time, return time, start hold time, and stop hold time.
- **Ext Leading:** The instrument receives the trigger signal from the rear-panel **[AUX IN/OUT]** connector. A sweep is generated each time a TTL pulse with leading edge is received.
- **Ext Trailing:** The instrument receives the trigger signal from the rear-panel **[AUX IN/OUT]** connector. A sweep is generated each time a TTL pulse with trailing edge is received.
- **Manual:** When "Manual" is selected, click or tap the manual trigger key  or press the front-panel  key to initiate a sweep output immediately.

TIP

When "Internal" or "Manual" is selected, the generator outputs a TTL-compatible signal with the specified edge via the rear-panel **[AUX IN/OUT]** connector. Please refer to *Trigger Output Setup*.

7.8 Mark Frequency

For frequency sweeps, the sync signal outputs a high level at the beginning of the sweep. If you disable the "Mark" function, the sync signal goes low at the end of the sweep. If you enable the "Mark" function, the sync signal goes low at the specified marker frequency.

After enabling the Sweep function, click or tap the Channel tab at the bottom to enter the Channel Setup Interface. Click or tap the **Mark** on/off switch to enable or disable the function. When it is enabled, you can click or tap the **Mark Freq** input field to set the mark frequency. Mark frequency is limited by the sweep "Start Frequency" and "Stop Frequency".

NOTE

For step sweep (the sweep points determined by the start frequency, stop frequency, and step number respectively are $f_1, f_2, \dots, f_n, f_{n+1}, \dots$), if the mark frequency setting is one of the

sweep point values, the sync signal is a TTL high level at the beginning of the sweep and a low level at the mark frequency. If the mark frequency is not equal to any of the sweep points values, the sync signal becomes a low level at the sweep point which is closest to this mark frequency (sweep up/down). Take sweeping down as an example. If the mark frequency is set to 1 MHz and the sweep points are 0.99 MHz and 1.01 MHz, then 0.99 MHz will be selected as the mark frequency to be applied to the digital system.

8 Burst

DG800 Pro can output a waveform for a specified number of cycles, called a burst. You can use Sine, Square, Ramp, Arb (except DC), and Noise (only available for "Gated" Burst) to generate burst waveforms.

Click or tap the "Output Mode" drop-down button to select "Burst" to enter the Burst Setting Interface, as shown in the figure below. You can click or tap one of the tabs at the bottom to enter the Continuous Setting Interface, Burst Setting Interface, or Channel Setup Interface. For Continuous Setting Interface and Channel Setup Interface, please refer to *Continuous* and *Channel Setup* respectively. This chapter only describes the burst settings.



TIP

The Burst mode cannot be enabled when the fundamental frequency is less than or equal to 125 μHz.

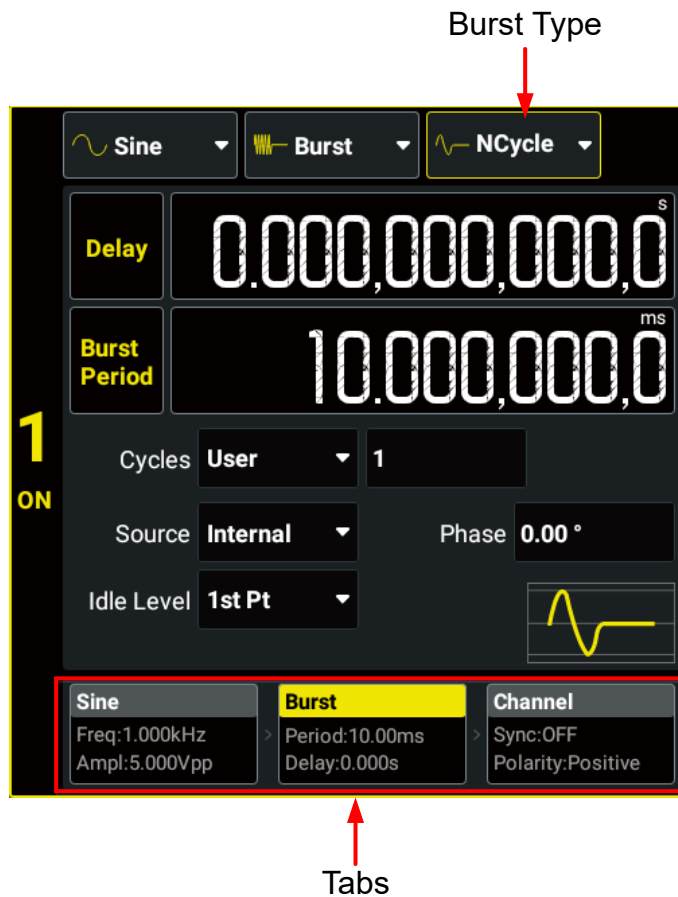

Figure 8.1 Burst Setting Interface

8.1 Burst Type

DG800 Pro can output two types of bursts: N-Cycle Burst (default) and Gated Burst. In the Burst Setting Interface (*Figure 8.1*), click or tap the "Burst Type" drop-down button to select "NCycle" or "Gated". The table below illustrates the trigger sources and waveform parameters available for the two burst types.

Burst Type		Trigger Source	Burst Parameters
N-Cycle Burst	User-defined	Internal/External/Manual Trigger	Delay, Burst Period, Source, Trigger Output (only available for manual trigger and internal trigger), Phase, Cycles, Idle Level
	Infinite	External/Manual Trigger	Delay, Source, Trigger Output (only available for manual trigger), Phase, Cycles, Idle Level
Gated Burst		External Trigger	Starting Phase, Polarity, Idle Level

N-Cycle Burst

In N-Cycle Burst mode, the instrument outputs a waveform for a specified number of cycles (burst count) each time trigger is received. You can also set the burst count to "Infinite". Available waveform functions for N-Cycle burst include Sine, Square, Ramp, and Arb (except DC). Click or tap the **Cycles** drop-down button to set the burst count.

- **Infinite:** Infinite Burst sets the burst count to "infinite". The instrument outputs a continuous waveform when a trigger signal is received.
- **User:** Click or tap the **Cycles** input field and use the pop-up numeric keypad to set the burst count. It ranges from 1 (default) to 1 M. If you change the burst count, the instrument automatically increases the burst period to accommodate the burst count (but the waveform frequency will not be changed).

Gated Burst

In Gated Burst mode, the generator controls the waveform output based on the external signal level from the rear-panel **[AUX IN/OUT]** connector. Available waveform functions for Gated burst include Sine, Square, Ramp, Noise, and Arb (except DC). When the gate signal is "true", the instrument outputs a continuous waveform. When the gate signal is "false", the instrument first stops the current waveform output and remains at the voltage level corresponding to the "Idle Level" setting.

8.2 Burst Delay

Burst delay, which is only available for N-Cycle Burst mode, is the duration from the time when the instrument receives the trigger signal to the time when it starts to output the burst signal.

Click or tap the **Delay** input field and use the pop-up numeric keypad to set the delay. The default delay is 0 s and the resolution is 0.1 ns. The range of burst delay is related to the trigger source:

- Manual/external trigger: 0 s to 20 s.
- Internal trigger: 0 s to $(T_{burst} - \lceil T_{wave} \times N_{cycle} \div 6.4 \text{ ns} \rceil \times 6.4 \text{ ns} - 4 \mu\text{s})^{[1]}$, and less than or equal to 20 s.
 - T_{burst} : burst period
 - $T_{waveform}$: period of basic waveform (e.g. Sine and Square)
 - N_{cycles} : burst count

NOTE

[1]: $\lceil x \rceil$ indicates that x is rounded up.



8.3 Burst Phase

In Burst mode, the fundamental phase is no longer in effect. The phase characteristics are determined by the burst phase. When the burst type is set to "NCycle", click or tap the **Phase** input field to set the burst phase. When the burst type is set to "Gated", click or tap the **Start Phase** input field to set the phase. It ranges from -360° to 360°, and the default is 0°. The resolution is 0.01°.

- For Sine, Square, and Ramp, 0° is the point at which the waveform crosses 0 V (or DC offset) in a positive-going direction.
- Burst phase setting is not available for noise.
- For arbitrary waveforms, 0° is the first waveform point.

TIP

In Burst mode, the fundamental phase is fixed to 0° and cannot be modified.



8.4 Burst Period

Burst period is only available for internally triggered N-Cycle burst mode (user-defined burst count). Burst period is defined as the time from the start of a burst to the time when the next burst starts.

Click or tap the **Burst Period** input field and use the pop-up numeric keypad to set the period. It ranges from 4 μ s to 8 ks and the default is 10 ms. The resolution is 0.1 ns.

- Burst Period $\geq \lceil (\text{Burst Count} \times \text{Waveform Period}) \div 6.4 \text{ ns} \rceil \times 6.4 \text{ ns} + 4 \mu\text{s}^{[1]}$
- If the burst period is too short, the generator will increase it automatically to allow the output of the specified number of cycles.





NOTE

[1]: $\lceil x \rceil$ indicates that x is rounded up.

8.5 Burst Trigger Source

Available trigger sources for bursts include internal trigger, external leading edge, external trailing edge, and manual trigger. Click or tap the **Source** drop-down button and select the trigger source. The default is "Internal".

- **Internal:** Internal trigger is only available for N-Cycle Burst with user-defined burst count. When internal trigger is selected, the instrument outputs a burst of the specified cycles. The rate at which the burst is generated is determined by *Burst Period*. After completing the specified number of cycles, the instrument outputs the idle level and waits for the next trigger event.
- **Ext Leading:** When external leading edge is selected, the instrument receives the trigger signal from the rear-panel **[AUX IN/OUT]** connector. A burst is generated each time a TTL pulse with leading edge is received.
- **Ext Trailing:** When external trailing edge is selected, the instrument receives the trigger signal from the rear-panel **[AUX IN/OUT]** connector. A burst is generated each time a TTL pulse with trailing edge is received.
- **Manual:** Manual trigger is only available for N-Cycle Burst mode. When manual trigger is selected, click or tap the manual trigger key  in *Figure 8.1* interface or press the front-panel  key to initiate a burst output immediately. If the output of the corresponding channel is not enabled, the trigger will be ignored.

**TIP**

When "Internal" or "Manual" is selected, the generator outputs a TTL-compatible signal with the specified edge via the rear-panel **[AUX IN/OUT]** connector. Please refer to *Trigger Output Setup*.

8.6 Gate Polarity

Gate polarity is only available for Gated Burst mode. It enables the instrument to output burst signals at a high level or low level. The gate signal is applied to the rear-panel **[AUX IN/OUX]** connector.

In the Burst Setting Interface, click or tap the "Burst Type" drop-down button to select "Gated" and enter the Gated Burst Setting Interface. Click or tap the **Polarity** drop-down button to select "Positive" or "Negative". The default is "Positive".

- **Positive:** When the gate signal is a high level, the instrument outputs a continuous waveform. When the gate signal is a low level, the instrument first completes the waveform output of the current period and remains at the voltage level set in the "Idle Level".
- **Negative:** When the gate signal is a low level, the instrument outputs a continuous waveform. When the gate signal is a high level, the instrument stops the current output and remains at the voltage level set in the "Idle Level".

8.7 Idle Level

In Burst mode, the output will not be turned off when there is no burst output but will remain at a specified voltage level, which is called the idle level. In N-Cycle Burst mode, the generator outputs a carrier waveform with a specified number of cycles and then continues to output the idle level until a burst period is complete, as shown in the figure below. In Burst mode, the instrument will output the idle level when the gate signal is "false".

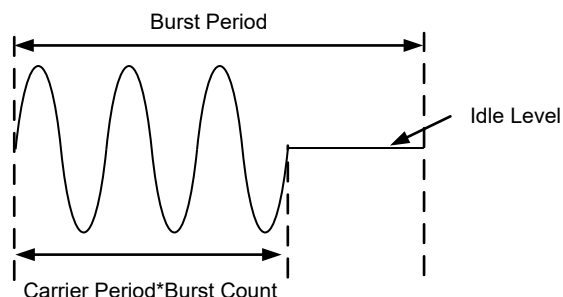

After enabling the Burst function, in Burst Setting Interface (*Figure 8.1*), click or tap the **Idle Level** drop-down button to select the idle level.

- **1st Pt:** Selects the level at the first point of the carrier waveform as the idle level.

- **Top:** Selects the level at the top point of the carrier waveform as the idle level.
- **Center:** Selects the level at the center point of the carrier waveform as the idle level.
- **Bottom:** Selects the level at the bottom point of the carrier waveform as the idle level.
- **User:** Selects the specified level as the idle level. When "User" is selected, click or tap the **Idle Level** input field and use the pop-up numeric keypad to set the idle level. It ranges from 0 to 65,535, and the default is 0.

**TIP**

When the noise is the carrier waveform, the idle level is fixed to 32768 and cannot be modified.

9 Sequence

A sequence is a combination of multiple individual waveforms in order. In Sequence mode, you can self-define the sequence and save the edited sequence to internal memory or external storage device (*.seq format).

Click or tap the "Output Mode" drop-down button to select "Seq" to enter the Sequence Setting Interface, as shown in the figure below. You can click to tap one of the tabs at the bottom to access the Sequence Setting Interface or Channel Setup Interface. For Channel Setup Interface, please refer to *Channel Setup*. This chapter only describes the sequence settings.

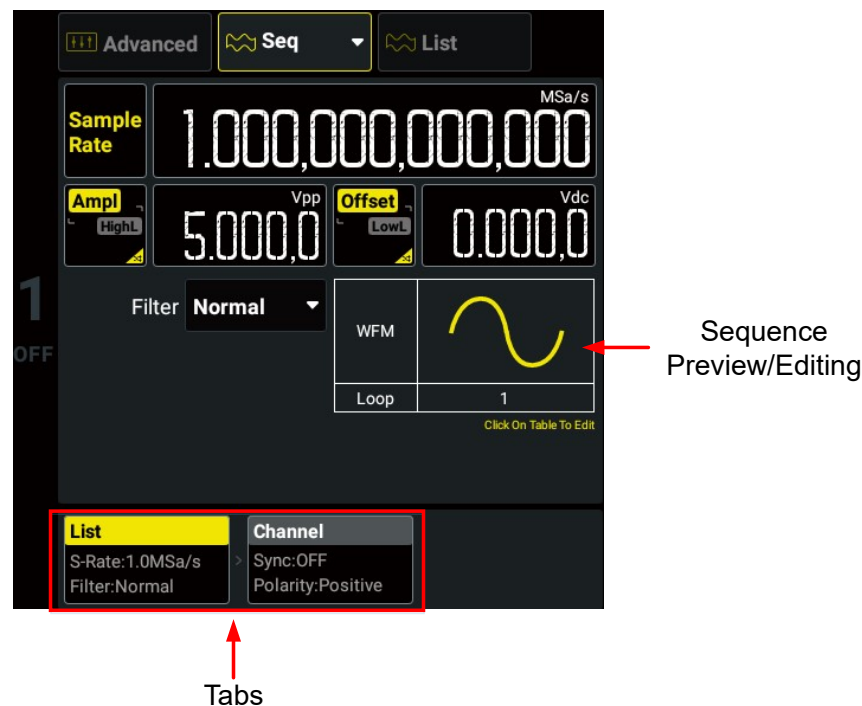

Figure 9.1 Sequence Setting Interface



TIP

The Sequence mode on/off status of CH1 and CH2 is always synchronized for two-channel models.

9.1 To Edit Sequence

In the Sequence Setting interface as shown in *Figure 9.1*, click or tap the "Sequence Preview/Editing" area to open the sequence editing table, as shown in the figure below.

SN	1	2	3	4	5	6	7
WaveForm	Sine	Sine	Sine	Sine	Sine	Sine	Sine
Loop	1	0	0	0	0	0	0
Length	16384	16384	16384	16384	16384	16384	16384

Figure 9.2 Sequence Editing Table

- **SN:** displays the step number from 1 to 64. Slide the table left and right to view all the steps.
- **WaveForm:** displays the wave type for step n. Click or tap the cell in this row to set the waveform for the specified step.
- **Loop:** displays the repeat count for step n. Click or tap the cell in this row to set the repeat count for the specified step.
- **Length:** displays the waveform length for step n. Click or tap the cell in this row to set the length for the specified step.

After the sequence function is enabled, by default, the table has a Sine step whose loop is 1. The loops of other steps are 0. You can follow the steps below to edit the sequence.

TIP

You can also use `:SOURCE<n>:TRACE:DATA:DAC16 <type>, <flag>, <data>` to self-define the waveform. For details, refer to *DG800 Pro/DG900 Pro Programming Guide*.

1. Click or tap the cell in the **WaveForm** row to select the wave type in the pop-up menu for the specified step.
2. Click or tap the cell in the **Loop** row to set the loop with the pop-up numeric keypad for the specified step. The maximum value is 256. When the entry loop is set to 0, the entry has no output.
3. Click or tap the cell in the **Length** row to set the length with the pop-up numeric keypad for the specified entry. The length ranges from 32 pts to 2 Mpts (8 Mpts/CH optional). The total points of all valid steps (the loop is not 0) in the current sequence cannot exceed 2 Mpts (8 Mpts/CH optional).
4. After editing, click or tap **Apply** to confirm modifications and set the sequence as the waveform of the current channel.

If you want to clear the current step configurations, click or tap **Clear** and the table will be restored to its default state.

9.2 To Save/Load Sequence

Save Sequence

After editing a sequence, you can save the sequence to the internal memory or external storage device.

1. In the interface as shown in *Figure 9.2*, click or tap **Save** and the "Store" menu is displayed.
2. Enter the target path in the internal/external memory. Click or tap **Save** and the virtual keypad is displayed.
3. Set the sequence name with the pop-up virtual keypad and then click or tap **Enter** to save the sequence. Then you can see the sequence that you saved under the target path.

Load Sequence

You can load the sequence files stored in the internal memory or external storage device.

1. In the interface as shown in *Figure 9.2*, click or tap **Load** and the "Store" menu is displayed.
2. Enter the target path in the internal/external memory and tick the sequence file (*.seq) that you want to load.
3. Click or tap **Load** and the instrument will open the file in the sequence editing table and apply to the current channel.



TIP

For general operations of the "Store" menu, please refer to *Storage Management*.

9.3 To Set Sequence Parameters

In the interface as shown in *Figure 9.1*, you can also set the following parameters.

Sample Rate

Click or tap the **Sample Rate** input field to set the sample rate for the sequence. The sample rate ranges from 1 μ Sa/s to 312.5 MSa/s, and the default is 1 MSa/s.

Amplitude/High Level

Refer to *To Output Sine Wave* to set the amplitude/high level. Note that Vrms and dBm are not available for the unit of the sequence amplitude.

Offset/Low Level

Refer to *To Output Sine Wave* to set the offset/low level.



Filter Mode

Click or tap the **Filter** drop-down button to select the filter mode.

- **Normal:** It has wide and flat frequency response as well as short edge time, but the step response produces a large overshoot.
- **Step:** It has more ideal step response, narrow bandwidth, longer rise/fall time, and longer edge time.
- **Interpolation:** It guarantees the output of signals with no distortion at all.

10 Frequency Counter

DG800 Pro series provides the frequency counter function. It allows you to measure the frequency, period, duty cycle, positive pulse width and negative pulse width for the external input signal. The counter measuring signal is applied to the front-panel [Counter] connector. You can enter the counter setting menu in the following ways (for two-channel models):

- Click or tap the Counter label at the bottom of the interface to access the "Counter" menu.
- Press the front-panel  key to access the "Counter" menu.
- Press the front-panel  key to access the "Counter" menu and enable the counter function.

When the counter menu is enabled (for two-channel models), the original CH2 configuration area is replaced by the counter menu, as shown in the figure below.

Click or tap the CH2 channel label or press the front-panel  to disable the counter menu.

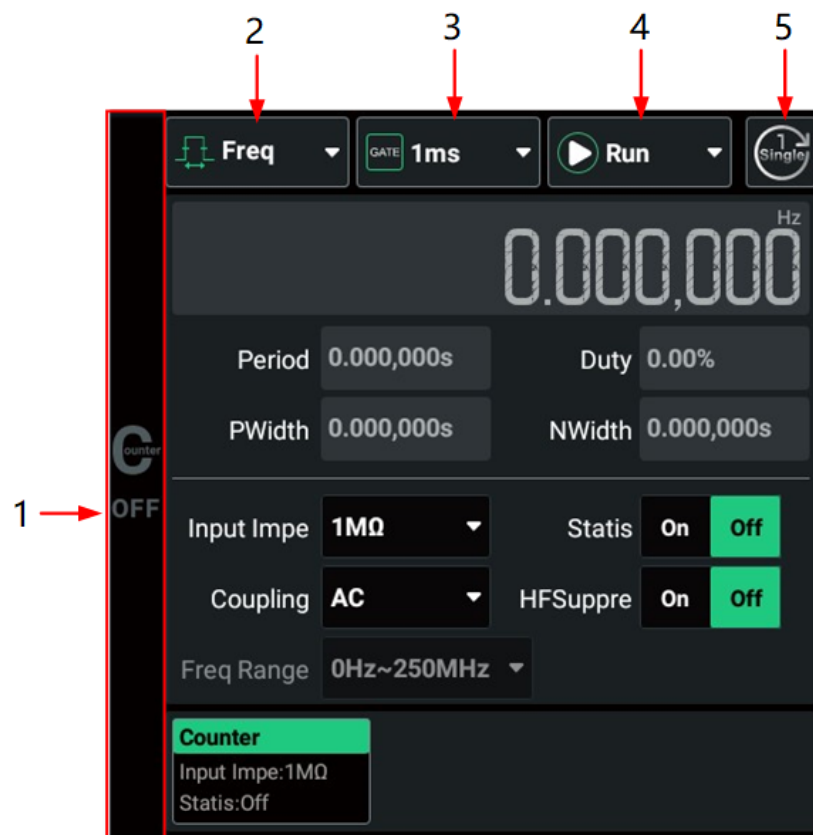



Figure 10.1 Counter Menu

1. Counter On/Off Identifier
2. Measurement Item Drop-down button
3. Gate Time Drop-down button
4. Operating Status Drop-down button
5. Single Measurement Key

10.1 To Enable the Counter

Press the front-panel  key to enable the counter function. You can also click or tap the counter on/off identifier in the counter menu to enable the counter function. After the counter is enabled, "ON" will be displayed in the counter on/off identifier and the counter label is highlighted.



TIP

When the counter is enabled, the output of CH2 will be disabled for two-channel models. You are not allowed to configure CH2.

10.2 To Set the Counter

In the "Counter" menu, you can set the following parameters for the counter.

Measurement Parameter

Available parameters include frequency (default), period, duty cycle, positive pulse width, and negative pulse. In the "Counter" menu, click or tap the "Measurement Item" drop-down button to select the measurement item. The selected measurement item is displayed. When the statistical function is enabled, the statistical information of this item will be displayed (*Statistical Function*).

Operating Status

In the "Counter" menu, click or tap the "Operating Status" drop-down button to set the counter operating status to "Run", "Stop", or "Single".

- **Run:** measures the input signal continuously based on the current configuration.
- **Single:** performs a single measurement and then enters the "Stop" state. You can also click or tap the  key to perform a single measurement (in any operating status).
- **Stop:** completes the current measurement and then stops.

Gate Time

In the "Counter" menu, click or tap the "Gate Time" drop-down button to set the gate time to Auto, 1 ms, 10 ms, 100 ms, 1 s, 10 s, 100 s, 1000 s, or 10,000 s. The default is Auto.

Input Impedance

In the "Counter" menu, click or tap the **Input Impe** drop-down button to select "50 Ω " or "1 M Ω " (default).

High Frequency Suppression

When the input impedance is set to 1 M Ω , the HF Suppression function is available. In low-frequency signal measurements, this function can be used to filter the high-frequency components (>60 kHz) in a way to improve the measurement accuracy.

In the "Counter" menu, click or tap the **HFSuppre** on/off switch to enable or disable the HF Suppression function.

Coupling Type

In the "Counter" menu, click or tap the **Coupling** drop-down button to select "DC" or "AC". Note that the coupling type is fixed to "DC" when the input impedance is set to 50 Ω .

- **DC:** DC coupling, both the DC and AC components of the signal under test can pass the channel.
- **AC:** AC coupling, the DC components of the signal under test are eliminated.

Frequency Range

In the "Counter" menu, click or tap the **Freq Range** drop-down button to select the frequency range.

- When the input impedance is set to 50 Ω , you can set the frequency range to Hz~250 MHz, 250 MHz~500 MHz.
- When the input impedance is set to 1 M Ω , the frequency range is fixed to 0 Hz~250 MHz.

Statistical Function

Please refer to *Statistical Function*.

10.3 Statistical Function

The statistical function can calculate the maximum, minimum, average, and standard deviation of the current measurement parameter automatically and displays the variation of the measurement values in "Digital" or "Curve" display mode. In the counter setting interface (*Figure 10.1*), click or tap the **Statis** on/off switch to enable

or disable the statistical function. After the statistical function is enabled, you can click or tap the "Statis" tab to enter the statistical interface, as shown in the interface below.



Figure 10.2 Counter Statistical Interface

Click or tap the **Clear** key to clear the current results. The count will restart from 1.



TIP

The maximum count is 256 for the counter measurements. If the measurement count exceeds 256, the instrument will clear measurement data and restart the count.

11 Channel Copy

DG800 Pro supports the Channel Copy function between two channels, allowing you to copy the states of one channel to the other one. DG821 Pro should have the two-channel upgrade option installed. The copy information is as shown in the table below.

Click or tap **Channel Copy** at the bottom of the screen to open the channel copy menu. You can perform the copy operation between two channels:

- Click or tap **CH1 > CH2** to copy the states and waveforms of CH1 to CH2.
- Click or tap **CH2 > CH1** to copy the states and waveforms of CH2 to CH1.
- Click or tap **Swap** to exchange the states of CH1 and CH2.



TIP

The Channel Copy function is disabled when channel track is enabled.

Table 11.1 Dual-channel operation parameters

(√ indicates available; × indicates not available; * indicates available in certain conditions)

Parameter	Track	Copy
Basic Functions		
Channel Output State	×	×
Output Mode	√	√
Basic Waveform	√	√
Frequency	√	√
Frequency Coupling	Disabled	Disabled
Period	√	√
Amplitude	√	√
Amplitude Coupling	Disabled	Disabled
Offset	√	√
Phase	√	√
Phase Coupling	Disabled	Disabled
Square Duty Cycle	√	√
Ramp Symmetry	√	√
Pulse Width	√	√
Rising Edge	√	√
Trailing Edge	√	√
Arb Type	√	√
Harmonic Type	√	√

Parameter	Track	Copy
Harmonic Order	√	√
Harmonic Combination	√	√
Order Harmonic Amplitude	√	√
Order Harmonic Phase	√	√
Combine Harmonic Amplitude List	√	√
Combine Harmonic Phase List	√	√
Burst		
State	√	√
Mode	√	√
(Trigger) Source	√	√
Burst Delay	√	√
Cycles	√	√
Period	√	√
Phase	√	√
Gate Polarity	√	√
Idle Level	√	√
Sweep		
State	√	√
Mode	√	√
Trigger Source	√	√
Start Frequency	√	√
Stop Frequency	√	√
Center Frequency	√	√
Frequency Span	√	√
Start Hold Time	√	√
Stop Hold Time	√	√
Sweep Time	√	√
Return Time	√	√
Mark On/Off	√	√
Mark Frequency	√	√
Modulation		
Modulation Type	√	√
Modulation Source	√	√
Modulating Waveform	√	√
Modulation Frequency	√	√
Modulation Depth	√	√
DSSC	√	√
Frequency Deviation	√	√
Phase Deviation	√	√
Duty Cycle Deviation	√	√
Width Deviation	√	√

Parameter	Track	Copy
Modulation Polarity	√	√
Modulation Rate	√	√
Modulation Amplitude	√	√
Hop Frequency	√	√
Phase	√	√
SUM Waveform ^[1]	*	*
SUM Frequency	√	√
SUM Ratio	√	√
Channel		
Sync On/Off	√	√
Sync Port	√	√
Sync Polarity	√	√
Invert	√	√
Impedance	√	√
Trigger output	√	√

**NOTE**

[1]: When the SUM waveform is set to a channel, the track function and channel copy function are not available.

12 Channel Setup

In the interface as shown in [Figure 4.6](#), click or tap the Channel Tab to enter the Channel Setup Interface, as shown in the interface below.

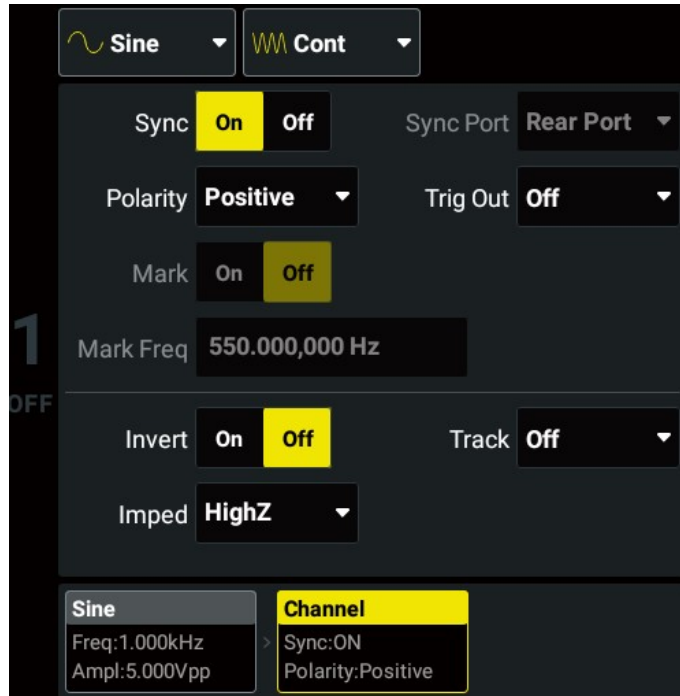

Figure 12.1 Channel Setup Interface

12.1 Sync Signal Setup

This series can output the sync signals of basic waveforms (except noise, DC, and harmonic), sweep waveforms, bursts, and modulated signal. The instrument outputs the sync signals of the two channels via the rear-panel **[AUX IN/OUT]** connector. You can set the on/off and output polarity for the sync signals of two channels.

Sync On/Off

Click or tap the **Sync** on/off switch to enable or disable the output of the sync signal. If the Sync function is enabled, the sync signal is output from the specified sync port when the channel output is enabled; if the Sync function is disabled, the specified sync port outputs a logic low level. For details, refer to [Table 12.1 Sync Signal of Different Output Modes \(Positive Polarity\)](#).

Sync Port

The current version only supports the rear port. When the sync signal output is enabled, it is output from the rear-panel **[AUX IN/OUT]** connector of the corresponding channel.

**TIP**

It is disabled when the channel uses external trigger source or external modulation source.

Sync Polarity

It sets the output polarity of the sync signal to trigger an external device that may require rising edge trigger or falling edge trigger. Click or tap the **Polarity** drop-down button to select "Positive" or "Negative".

- **Positive:** outputs normal sync signals.
- **Negative:** outputs inverted sync signals.

Mark Frequency

When the output mode is set to "Sweep", you can enable the "Mark" function. After the "Mark" function is enabled, the sync signal goes low at the specified mark frequency. For details, please refer to *Mark Frequency*.

Table 12.1 Sync Signal of Different Output Modes (Positive Polarity)

Output Mode	Descriptions
Continuous Mode	<p>In Continuous mode (except noise and harmonic), the frequency and duty cycle of the sync signal are related to the waveform output frequency.</p> <ul style="list-style-type: none"> • Output frequency ≤ 30 MHz: the sync signal frequency is the fundamental frequency. The sync signal duty cycle for square equals to the duty cycle of the output waveform. The sync signal duty cycle for sine, ramp, pulse, and Arb (except DC) is 50%. • Output frequency ≥ 30 MHz: the sync signal frequency is waveform frequency/2 and the duty cycle is 50%.
Modulation Mode	<p>In Modulation mode, the sync signal is a square waveform with 50% duty cycle. In the first half period of the waveform, the sync signal is a TTL high level.</p> <ul style="list-style-type: none"> • For AM, FM, PM and PWM, the frequency of the sync signal is the modulation frequency. • For ASK, FSK, and PSK, the frequency of the sync signal is the modulation rate. • For SUM, the frequency of the sync signal is the SUM frequency. <p>TIP</p>

Output Mode	Descriptions
	<p>When an external modulation source is selected, the rear port ([AUX IN/OUT]) is used to accept the external modulation signal and there is no sync signal output.</p>
Sweep Mode	<ul style="list-style-type: none"> • With "Mark" function disabled, the sync signal is a TTL high level at the beginning of the sweep and goes low when the sweep stops. • With "Mark" function enabled, the sync signal is a TTL high level at the beginning of the sweep and goes low at the mark frequency. For step sweeps, if the mark frequency is not equal to any of the sweep points values, the sync signal becomes a low level at the sweep point which is closest to this mark frequency (sweep up/down). <p>TIP</p> <ul style="list-style-type: none"> • When the trigger source is an external trigger source, the rear port ([AUX IN/OUT]) is used to accept the external trigger signal and there is no sync signal output. • When the trigger output is enabled, the rear port ([AUX IN/OUT]) is used to output the trigger signal and there is no sync signal output.
Burst Mode	<ul style="list-style-type: none"> • Infinite N-Cycle Burst: the sync signal is output at a high level. • User-defined N-Cycle Burst: the sync signal is a TTL high level at the beginning of the burst. It becomes a TTL low level after a specified number of cycles is completed. The sync signal frequency is the reciprocal of the burst period. Duty cycle is carrier period*cycles/burst period. • Gated Burst: There is no sync signal output. <p>TIP</p> <ul style="list-style-type: none"> • When the trigger source is an external trigger source, the rear port ([AUX IN/OUT]) is used to accept the external trigger signal and there is no sync signal output. • When the trigger output is enabled, the rear port ([AUX IN/OUT]) is used to output the trigger signal and there is no sync signal output.

12.2 Trigger Output Setup

In Burst or Sweep mode, when the trigger source is set to "Internal" or "Manual", the generator outputs a TTL-compatible signal with the specified edge via the rear-panel [AUX IN/OUT] connector.

**NOTE**

- In internal trigger, the generator outputs a square waveform with 50% duty cycle via the rear-panel **[AUX IN/OUT]** connector at the beginning of the burst/sweep.
- In manual trigger, the generator outputs a pulse with greater than 4 μs pulse width via the **[AUX IN/OUT]** connector at the beginning of the burst/sweep.
- In external trigger, the **[AUX IN/OUT]** connector is used as the input terminal of external trigger signals and does not support trigger output.

Click or tap the **Trig Out** drop-down button to specify the edge of the trigger output signal. The default setting is "Off".

- Off: disables the trigger output signal.
- Leading: outputs the trigger signal of the leading edge.
- Trailing: outputs the trigger signal of the trailing edge.

12.3 Channel Output Setup

Output Polarity

You can use either the normal mode or Invert mode to output signals. Click or tap the **Invert** on/off switch to enable or disable the invert function. The default is "Off".

The waveform is inverted relative to the offset voltage. As shown in the figure below, relative to the offset voltage, the waveform is inverted.

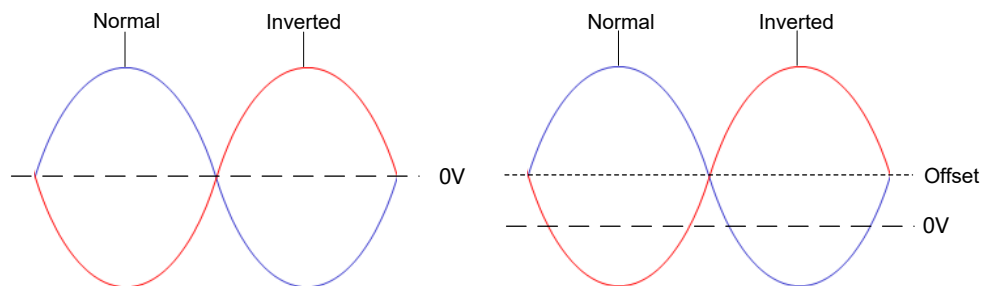
**TIP**

- Setting the waveform invert does not invert the sync signals related to the waveform. To invert the sync signal, refer to *Sync Polarity*. Set the polarity of the sync signal to "negative".
- The offset voltage remains unchanged when the waveform is inverted.

Channel Track

DG800 Pro supports the channel track function (DG821 Pro should have the two-channel upgrade option installed). When the Track function for the specified channel is enabled, you can copy the parameters and states (*Table 11.1 Dual-channel operation parameters*) of the channel to the other channel. The Track function makes

it easier to configure the same parameters for two channels. Click or tap the **Track** drop-down button to select "On", "Inverted", or "Off".

- **On:** enables the Track function. For example, if the Track function for CH1 is enabled, the instrument automatically copies the parameters and states (except channel output on/off state) of CH1 to CH2. When the parameters and states of CH1 are modified, the modifications also apply to CH2. In this way, the two channels can output identical signals (channel enabled)
- **Inverted:** the Track function is enabled. The target channel and the source channel have opposite output polarities.
- **Off:** disables the Track function. It is the default setting.



TIP

- When the coupling mode (*Coupling Setup*) is enabled, enabling the Track function automatically disables the channel coupling function.
- The Track function is disabled if the Channel Copy function is enabled for a channel and the SUM source is the other channel.
- The Track function is disabled when the Sequence mode, Counter, or front port sync output is enabled.

Impedance

The output impedance setting affects the output amplitude and DC offset. This instrument has a fixed series output impedance of 50 Ω to each front-panel output connector. If the actual load impedance differs from the value specified, the voltage level displayed would not match the voltage level of the device under test. To ensure correct voltage level, the load impedance setting must match the actual load.

Click or tap **Imped** drop-down button to select "HighZ" or "Load". If "Load" is selected, you can click or tap the **Imped** input field to define the impedance. The range is from 1 Ω to 10 k Ω .



NOTE

- After that, the instrument will adjust the output amplitude and offset voltage automatically. For example, the current amplitude is 5 Vpp. At this point, change the output impedance from 50 Ω to HighZ and the amplitude displayed in the input field will be doubled to 10 Vpp. If the output impedance is changed from HighZ to 50 Ω , the amplitude will be reduced to half of the previous value (2.5 Vpp). Note that only the displayed values change with the parameter and the actual output from the generator does not change.
- If the impedance is set to "HighZ", the amplitude unit cannot be set to "dBm".

13 Coupling Setup

DG800 Pro supports frequency, amplitude, and phase coupling. DG821 Pro should have the two-channel upgrade option installed. Click or tap  > **Coupling** to enter the "Coupling" menu.

In the "Coupling" menu, the **Cpl Base** displays the base channel for coupling. It is the currently selected channel. You can select the other channel as the base channel. When the coupling function is enabled, if the frequency, amplitude, or phase of one channel is changed, the corresponding parameter of the other channel will be adjusted automatically according to the specified deviation or ratio. This section describes how to set coupling.

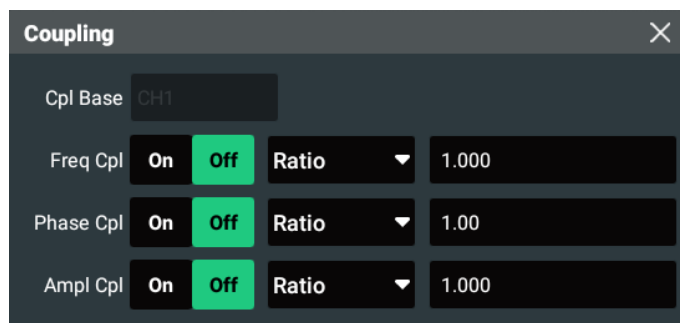

Figure 13.1 "Coupling" Menu

The coupling function is available only when the output mode of both channels is set to Continuous. The following table shows the relationship between the coupling mode and basic waveform.

(√ indicates available; × indicates not available)

Coupling Function	Sine	Square	Ramp	Pulse	Noise	Arb (not DC)	DC	Harmonic
Frequency Coupling	√	√	√	×	×	×	×	×
Amplitude Coupling	√	√	√	×	√	√	×	×
Phase Coupling	√	√	√	×	×	×	×	×

Frequency Coupling

Frequency coupling allows you to couple frequencies between channels, either by a constant deviation or ratio between them.

1. Click or tap the **Freq Cpl** on/off switch to enable or disable the frequency coupling. The default setting is "Off".
2. Click or tap the **Freq Cpl** drop-down button to select "Offset" or "Ratio". Then click or tap the input field to set the deviation or ratio value.
 - Offset: the frequency deviation between CH1 and CH2. Set the frequency of base channel to F_{basic} and the frequency deviation to F_{dev} , then the frequency of the other channel is $F = F_{\text{basic}} + F_{\text{dev}}$.
 - Ratio: the frequency ratio of CH1 and CH2. Set the frequency of base channel to F_{basic} and the frequency ratio to F_{ratio} , then the frequency of the other channel is $F = F_{\text{basic}} * F_{\text{ratio}}$. The ratio ranges from 0.001 to 1000.

Phase Coupling

Phase coupling allows you to couple phases between channels, either by a constant deviation or ratio between them.

1. Click or tap the **Phase Cpl** on/off switch to enable or disable the phase coupling. The default setting is "Off".
2. Click or tap the **Phase Cpl** drop-down button to select "Offset" or "Ratio". Then click or tap the input field to set the deviation or ratio value.
 - Offset: the phase deviation between CH1 and CH2. Set the phase of base channel to P_{basic} and the phase deviation to P_{dev} , then the phase of the other channel is $P = P_{\text{basic}} + P_{\text{dev}}$.
 - Ratio: the phase ratio of CH1 and CH2. Set the phase of base channel to P_{basic} and the phase ratio to P_{ratio} , then the phase of the other channel is $P = P_{\text{basic}} * P_{\text{ratio}}$. The ratio ranges from 0.01 to 100.

Amplitude Coupling

Amplitude coupling allows you to couple amplitudes between channels, either by a constant deviation or ratio between them.

1. Click or tap the **Ampl Cpl** on/off switch to enable or disable the amplitude coupling. The default setting is "Off".
2. Click or tap the **Ampl Cpl** drop-down button to select "Offset" or "Ratio". Then click or tap the input field to set the deviation or ratio value.
 - Offset: the amplitude deviation between CH1 and CH2. Set the amplitude of base channel to A_{basic} and the amplitude deviation to A_{dev} , then the amplitude of the other channel is $A = A_{\text{basic}} + A_{\text{dev}}$.

- Ratio: the amplitude ratio of CH1 and CH2. Set the amplitude of base channel to A_{basic} and the amplitude ratio to A_{ratio} , then the amplitude of the other channel is $A = A_{\text{basic}} * A_{\text{ratio}}$. The ratio ranges from 0.001 to 1000.

**TIP**

- When the coupling mode is set to "ratio", if the frequency, amplitude or phase of any channel exceeds the upper/lower limit after calculation according to the coupling rules due to modifying the coupling ratio, switching waveform, or changing waveform parameters, the generator will automatically adjust the waveform parameters of the base channel to avoid parameter overlimit.
- When the coupling mode is set to "deviation", if the frequency, amplitude or phase of any channel exceeds the upper/lower limit after calculation according to the coupling rules due to modifying the coupling deviation, the generator will automatically adjust the coupling deviation to avoid parameter overlimit; if it is due to switching waveform or changing waveform parameters, the corresponding coupling function is disabled.
- The coupling function is disabled when the channel track or counter is enabled.

14 Align Phase

DG800 Pro provides the Align Phase function. DG821 Pro should have the two-channel upgrade option installed. When the output mode is set to Continuous (except noise and DC), Sweep mode (internal trigger), or Burst mode (internal trigger), click or tap the **Align Phase** key at the bottom. The instrument will adjust the phase settings of the two channels and set an internal zero-phase reference point.

For two signals whose frequencies are identical or in multiple, you can use this function to align their phases. For example, the instrument outputs a sine waveform (1 kHz, 5 Vpp) with 0° phase from CH1 and a sine waveform (1 kHz, 5 Vpp) with 180° phase from CH2. Use an oscilloscope to acquire waveforms from the two channels and then display the acquired two waveforms. You will see that the waveforms shown on the oscilloscope do not always have a phase deviation of 180° . At this point, click or tap the **Align Phase** key. The waveforms shown on the oscilloscope will have a phase deviation of 180° without any adjustment of the start phase of the generator.

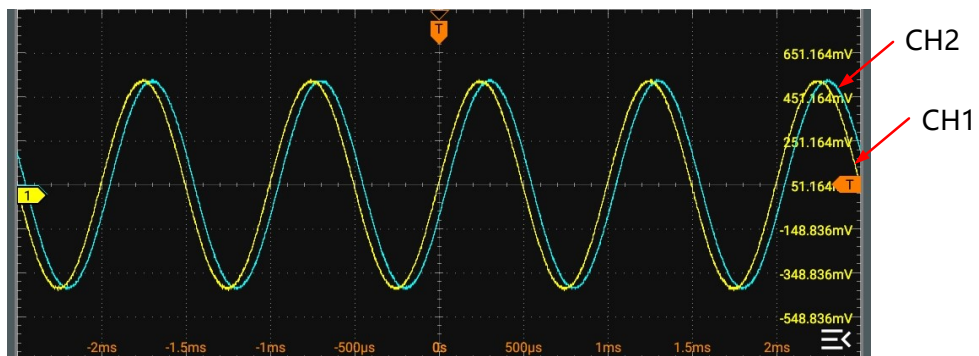

Figure 14.1 Before Aligning Phase

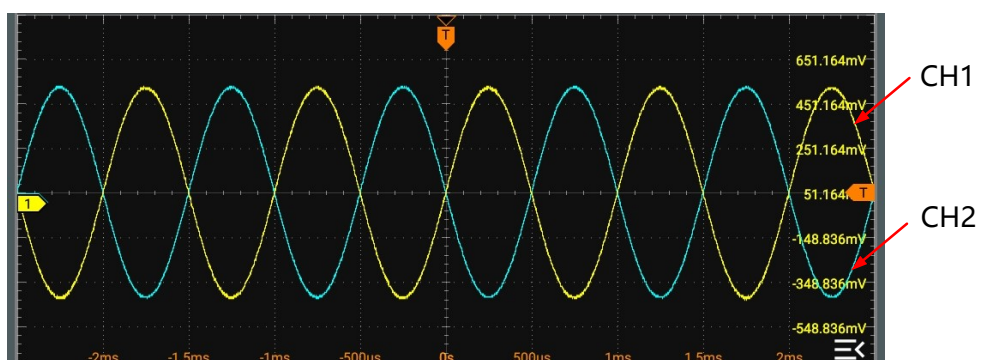



Figure 14.2 After Aligning Phase

15 Storage Management

You can store the screen capture or self-defined sequence waveforms to the internal memory or external storage device. This series provides a USB HOST interface on the front panel used to connect the USB storage device for external storage. The local directory is "Local Disk (C)" and the external storage device is displayed as "USB Disk (D)".

You can access the "Store" menu in the following ways.

- Click or tap **Store/Recall** at the bottom of the interface to enter the "Store" menu.
- Press the front-panel  key to enter the "Store" menu.

15.1 To Select the File

You need to select the desired file/folder(s) before any further operation.

1. Select the Disk

By default, the menu displays the content of "Local Disk(C)". You can switch to the external storage device in the drop-down menu at the upper-left side of the menu. For example, after "USB Disk(D)" is selected, the menu will display the content of the external storage device-D disk.

TIP

Before using the external storage device, please make sure that the USB storage device (FAT32, NTFS or exFAT format) is properly connected.

2. Enter the Target Directory

Click or tap the folder to enter the target directory.

3. Select the File/Folder

Tick the check box next to the file or folder and the box will be displayed as . You can click or tap the box again to cancel the selection. The check box restores to its original state.

TIP

You can also tick the icon at the upper-right side of the menu to select all the files and folders under the current directory. Click or tap  again to cancel the select-all operation.

15.2 To Create New Folder

You can create new folders in the menu. Click or tap **New directory** at the bottom of the menu and set the folder name with the pop-up virtual keypad. A new folder will be created under the current path with the file name.

15.3 Cut and Copy

Cut a File to a Specified Directory

Select a specified file. Click or tap **Cut** and then access the target directory. Click or tap **Paste** to complete the operation.

Copy a File to a Specified Directory

Select a specified file. Click or tap **Copy** and then access the target directory. Click or tap **Paste** to complete the operation.

15.4 Rename

Select a specified file. Click or tap **Rename** and set the name with the pop-up virtual keypad.



TIP

DG800 Pro can only identify the file whose name contains Chinese characters or English letters (including numbers and underscores). The file or folder named by other characters cannot appear in the storage menu.

15.5 Delete

Under the current directory, select the file or folder (empty) that you want to delete. Click or tap **Delete** to delete the selected file or folder. You cannot delete folders that are not empty.



16 Upgrade

You can upgrade the system following the steps below.

1. Ensure that the USB device is correctly connected to the instrument.
2. Then click or tap **Store/Recall** at the bottom of the interface or press the front-panel  key to enter the "Store" menu.
3. Refer to *Storage Management*. Select the upgrade file and then click or tap **Upgrade**. In the pop-up menu, click or tap **OK** to perform the local upgrade operation.

17 System Utility Function Setting

In the "Utility" menu, you can set the I/O parameters and the system-related function parameters. To enter the "Utility" menu, perform the following operations.

- Click or tap the notification area at the lower-right corner of the interface to enter the "Utility" menu.
- Press the front-panel  key to enter the "Utility" menu.
- Click or tap the function navigation icon  at the lower-left corner of the interface, and then select **Utility** to enter the "Utility" menu.

17.1 I/O Setting

In the **Utility** menu, click or tap **I/O** to enter the I/O setting menu to configure the following parameters.

Network Status

Different prompts will be displayed according to the current network connection status.

- Network Config Succeeded!
- Acquiring IP..
- IP Conflict!
- DISCONNECTED!
- DHCP Config Failed
- Read Status Fail!
- CONNECTED
- Invalid IP
- IP lost
- Please wait...

IP Configuration Type

The configuration type of the IP address can be DHCP, Auto IP, or Static IP. In different IP configuration types, the configurations for IP address and other network parameters are different.

- **DHCP**

If "DHCP" is selected, the DHCP server in the current network will assign the network parameters (e.g. IP address, Subnet, Gateway, and DNS) for the instrument.

- **Auto IP**

When "Auto IP" is selected, the instrument will acquire the IP address ranging from "169.254.0.1" to "169.254.255.254" and the subnet mask (255.255.0.0) automatically based on the current network configuration. The "Auto IP" works only when "DHCP" is not selected or connection is failed.

- **Static IP**

If "Static IP" is selected, the instrument is configured with static IP. In this case, you need to disable DHCP and Auto IP manually. Then you need to configure the parameters such as "IP address", "Subnet", "Gateway", and "DNS" manually. At this time, you can self-define the network parameters (e.g. IP address) of the instrument.

- **Set the IP address**

The format of the IP address is nnn.nnn.nnn.nnn. The range of the first segment (nnn) of the address is from 0 to 255 (except 127); wherein, the valid range is from 0 to 223. The range for the other three segments is from 0 to 255. You are recommended to ask your network administrator for an IP address available.

- **Set the subnet mask**

The format of the subnet mask is nnn.nnn.nnn.nnn. Wherein, the range of "nnn" is from 0 to 255. You are recommended to ask your network administrator for a subnet mask available.

- **Set the default gateway**

You can set this parameter in Static IP mode. The format of the gateway is nnn.nnn.nnn.nnn. The range of the first segment (nnn) is from 0 to 223 (except 127), and the range for the other three segments is from 0 to 255. You are recommended to ask your network administrator for a gate address available.

- **Set the DNS address**

You can set this parameter in Static IP mode. The format of the DNS address is "nnn.nnn.nnn.nnn". The range for the first segment (nnn) of the address is from 0 to 223 (except 127); and the range for the other three segments is from 0 to 255. You are recommended to ask your network administrator for an address available.

Generally, you do not need to set the DNS, therefore this parameter setting can be ignored.

**TIP**

- When the three IP configuration types are all turned on, the priority of the parameter configuration from high to low is "DHCP", "Auto IP", and "Static IP".
- The three IP configuration types cannot be all turned off at the same time.

MAC Address

Displays the MAC address by the instrument. For each instrument, the MAC address is unique. When assigning the IP address for the instrument, the system uses the MAC address to identify the instrument.

VISA Address

Displays the VISA address currently used by the instrument.

Apply the Network Parameter Setting

Click or tap **Apply** to validate the current network parameter setting.

17.2 LXI

In the **Utility** menu, click or tap **LXI** to enter the LXI setting menu and configure the following parameters.

mDNS

Click or tap the mDNS on/off switch to enable or disable the multicast Domain Name System (mDNS). This system is used to provide the function of DNS server for service discovery in a small network without a DNS server.

Host Name

Click or tap the **Host Name** input field to set the host name. A maximum of 28-byte strings can be supported. When mDNS is enabled, you can also input "hostname.local" into the browser address bar to access Web Control.

Service Name

After the mDNS function is enabled, click or tap the **Service Name** input field to set the service name.

17.3 Basic Settings

In the **Utility** menu, click or tap **Setup** to access the basic setting menu.

Language

This instrument supports two languages. Both Chinese and English are available for the display of the help information, prompt messages, and interface. Click or tap the drop-down button of **Language** to select the specified system language.

Load Last

You can set the system configuration to be recalled when the instrument is powered on again after power-off. Click or tap the **Load Last** drop-down button to select "Default" or "Last". The default setting is "Last".

- **Last:** returns to the setting of the system at last power-off.
- **Default:** returns to the factory setting of the system.

Power Setting

Click or tap the **Power Set** drop-down button to select "Auto" or "Manual".

- **Manual:** After the instrument is connected to power, you need to press the power key to power on the instrument.
- **Auto:** After the instrument is connected to power, it will be powered on immediately.

This setting is stored in the non-volatile memory. It is not affected by the "restore factory defaults" operation.

Clock Source

This series generator provides an internal clock source (10 MHz) and accepts the external clock source from the rear-panel **[10 MHz In/Out]** connector. It also outputs the clock source via the **[10 MHz In/Out]** connector for the use of other equipment. Click or tap the **Clk Src** drop-down button to select "Internal" or "External". The default setting is "Internal".

If "External" is selected, the system will detect whether a valid external clock signal is applied to the rear-panel **[10MHz In/Out]** connector. If no valid clock source is detected, the prompt message "Not detect a valid external clock!" would be displayed and the clock source would be switched to "Internal".

TIP

You can synchronize two or more instruments by setting the clock source.

- **Synchronize two instruments:**

Connect the **[10MHz In/Out]** connector of Generator A ("Internal" clock source) to the **[10MHz In/Out]**connector of Generator B ("External" clock source) and then set identical output frequencies for the two instruments to realize their synchronization.

- **Synchronize multiple instruments:**

Divide the 10 MHz clock source of a generator ("Internal" clock source) into multiple channels, and then connect them to the **[10MHz In/Out]** connectors of other generators ("External" clock source) respectively, and finally set identical output frequencies for the instruments to realize synchronization among multiple instruments.



Number Format

You can set the display format of the decimal point and thousands separator in number parameters. This setting is stored in the non-volatile memory. It is not affected by the "restore factory defaults" operation.

- **Decimal Point:** click or tap the **Decimal** drop-down button to select "." or ",". The default setting is ".".
- **Thousands Separator:** click or tap the **Separate** drop-down button to select ".", ",", "Space", or "None". They cannot be set to "." or "," at the same time.

Brightness



Click or tap the **Brightness** input field to set the brightness of the display.

Beeper

Click or tap the **Beeper** on/off switch to turn on or off the beeper. When it is on, you can hear the beeper sound when operating the instrument or an error occurs.

Date and Time

Click or tap the **Show Time** on/off switch to turn on/off showing the date and time on the screen. When it is on, the system time is displayed in "hh:mm" format, and the date is displayed in "yyyy-mm-dd" format in the Notification Area at the lower-right corner of the screen. You can self-define the system date and time.

- **Date:** click or tap the **Date** input field and the date setting menu is displayed. Adjust the date and then click or tap **OK** to complete the date setting.
Otherwise, click or tap  to close the menu and cancel the modifications.
- **Time:** click or tap the **Time** input field and the time setting menu is displayed. Adjust the time and then click or tap **OK** to complete the time setting.
Otherwise, click or tap  to close the menu and cancel the modifications.

17.4 About this Instrument

In **Utility** menu, click or tap **About**, and then you can view the model, version, and other information about this instrument.

- **Model**
Indicates the product model.
- **Serial number**
Indicates the serial number of the product, the unique identification for the product.
- **Calibration Date**

- Indicates the last calibration date.
- **Analog Hardware Version**
Indicates the analog hardware version number of the product.
 - **Digital Hardware Version**
Indicates the digital hardware version number of the product.
 - **AFG FPGA Version**
Indicates the AFG FPGA version number of the product.
 - **AWG FPGA Version**
Indicates the AWG FPGA version number of the product.
 - **Counter FPGA Version**
Indicates the FPGA version number of the Counter.
 - **FGen Subsystem Version**
Indicates the function generator version number.
 - **UI Subsystem Version**
Indicates the user interface version number.
 - **WebServer SubSystem Version**
Indicates the version number of the network service system.
 - **Runtime System Version**
Indicates the version number of the operation system.

17.5 Print Screen

You can capture the current screen and save the image to the memory in different formats. In the **Utility** menu, click or tap **Print Screen** to enter the print screen setting menu. You can set the image format to "BMP" or "PNG".

Then click or tap the **Print Screen** button at the bottom of the interface. The screen image will be stored in the specified format. By default, the screen capture is saved to internal memory.

17.6 Option

In **Utility** menu, click or tap **Options** to view the option installation information. For detailed procedures of installing the options, please refer to *To View the Option Information and Install the Option*.

17.7 Open Source Acknowledgment

In the **Utility** menu, click or tap **Open Source** to view the open source acknowledgment of this series in the pop-up window.

17.8 Self-check

In **Utility** menu, click or tap **Self Check** to enter the "Self Check" menu. You can test the following self-check items for the device.

Key Test

Click or tap **Key Test** to enter the key test interface (virtual front-panel key).

At this time, you can press the front-panel keys to check whether the virtual keys are highlighted. If yes, it indicates that the keys work normally; if no, it indicates that there's something wrong with the keys. Click or tap **Exit** at the lower-right corner of the interface to exit the key test interface.

Touch Test

Click or tap **Touch Test** to enter the touch screen test interface.

Slide with your finger on the screen. If there is a line displaying at the empty area where you slide on the screen and the box that you tap turns out to be filled with green background, it indicates that the touch function of this area is normal. Click or tap **Exit** at the lower-left corner of the interface to exit the touch screen test interface.

Screen Test

Click or tap **Screen Test** to enter the screen test interface and check whether the defective pixel exists.

There are 15 screen test interfaces. Click or tap the screen to switch to the next screen test interface. Click or tap **Exit** at the upper-left corner of the interface to exit the screen test interface.

18 Preset Function

DG800 Pro provides one auto memory location (AUTO_RECALL) and five user-defined state memory locations (STATE_1 to STATE_5). You can store the instrument states to the specified state memory locations and recall them when necessary. Stored states include channel parameters, waveform parameters, and system parameters. Click or

tap  > **Preset** to enter the "Preset" menu, as shown in the figure below.

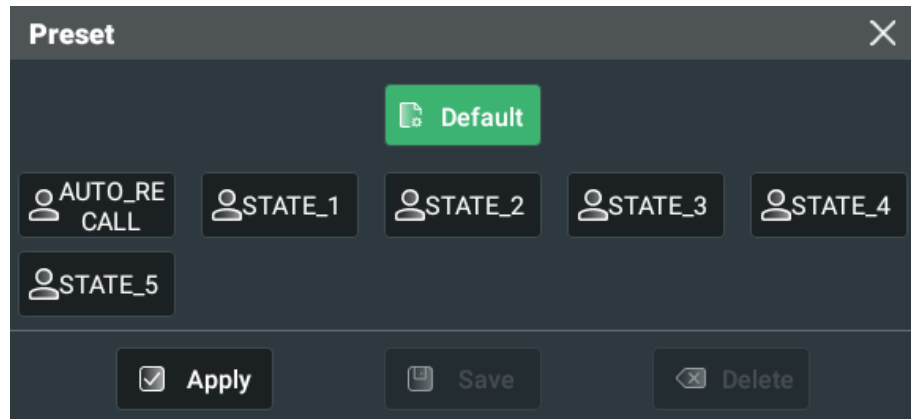



Figure 18.1 Preset Menu

TIP

If *Load Last* is set to "Last", the instrument automatically recalls the system configurations at last power-down (stored in AUTO_RECALL) when it is powered on. Also, the **AUTO_RECALL** is grayed out and cannot be modified.

Restore Default Settings

Click or tap **Default** > **Apply**. Then click or tap **OK** in the pop-up menu to reset the instrument to factory default settings. You can also press the front-panel  key. For the factory default values, refer to *Table 18.1 Factory Settings*.

Store Instrument States

Click or tap one state from **STATE_1** to **STATE_5**. Then click or tap **Save** to save the current system state to the specified location in the internal non-volatile memory. If *Load Last* is set to "Default", you can also store the system state to AUTO_RECALL. If an existing state file has been stored, this operation overwrites the original file.

Recall Instrument States

When a state file has been stored in the specified location, you can select the location and then click or tap **Apply** > **OK** to recall the state file.

Delete State Files

When a state file has been stored in the specified location, you can select the location and then click or tap **Delete** > **OK** to delete the state file.

Table 18.1 Factory Settings

Parameter	Factory Settings
Channel Output	
Basic Waveform	Sine
Output Mode	Continuous
Frequency	1 kHz
Period	1 ms
Amplitude	5 Vpp
Offset	0 Vdc
Phase	0°
Continuous	
Square Duty Cycle	50%
Ramp Symmetry	50%
Pulse Display Type	Pulse Width
Pulse Duty Cycle	50%
Pulse Width	500 μs
Pulse Leading Edge	3 ns
Pulse Trailing Edge	3 ns
Harmonic Type	Order
Harmonic Order	2
Harmonic Phase	0°
Harmonic Amplitude	5 Vpp
Arb Type	sinc
Burst	
State	Off
Burst Type	N-Cycle
Burst Period	10 ms
Trigger Source	Internal
Cycles	1
Phase	0°
Delay	0 s
Gate Polarity	Positive
Idle Level	1st Pt
Modulation	

Parameter	Factory Settings
AM	
Modulation Source	Internal
Shape	Sine
Modulation Frequency	100 Hz
Modulation Depth	100%
DSSC	OFF
FM	
Modulation Source	Internal
Shape	Sine
Modulation Frequency	100 Hz
Frequency Deviation	100 Hz
PM	
Modulation Source	Internal
Shape	Sine
Modulation Frequency	100 Hz
Phase Deviation	90°
ASK	
Modulation Source	Internal
Polarity	Positive
Modulation Rate	100 Hz
Modulation Amplitude	2 Vpp
FSK	
Modulation Source	Internal
Polarity	Positive
Modulation Rate	100 Hz
Hop Frequency	10 kHz
PSK	
Modulation Source	Internal
Polarity	Positive
Modulation Rate	100 Hz
Phase	180°
Pulse Width Modulation	
Modulation Source	Internal
Shape	Sine
Modulation Frequency	100 Hz
Duty Cycle Deviation	1%
Width Deviation	10 μs
SUM	
SUM Ratio	50%
SUM Frequency	100 Hz
SUM Waveform	Sine

Parameter	Factory Settings
Sweep	
Sweep Type	Linear Sweep
Trigger Source	Internal
Start Frequency	100 Hz
Stop Frequency	1 kHz
Center Frequency	550 Hz
Frequency Span	900 Hz
Mark Frequency	550 Hz
Sweep Time	1 s
Return Time	0 s
Start Hold Time	0 s
Stop Hold Time	0 s
Sequence	
Sample Rate	1 MSa/s
Filter Mode	Normal
Frequency Counter	
Counter On/Off	Off
Statistics	Off
High Frequency Suppression	Off
Input Impedance	1 MΩ
Gate Time	Auto
Coupling Type	AC
Coupling	
Coupling Base Channel	CH1
Frequency Coupling	Off
Frequency Coupling Mode	Ratio
Frequency Coupling Ratio	1
Frequency Coupling Offset	0
Phase Coupling	Off
Phase Coupling Mode	Ratio
Phase Coupling Ratio	1
Phase Coupling Offset	0
Amplitude Coupling	Off
Amplitude Coupling Mode	Ratio
Amplitude Coupling Ratio	1
Amplitude Coupling Offset	0
Channel Setup	
Sync On/Off	Off

Parameter	Factory Settings
Sync Port	Rear Port
Sync Polarity	Positive
Mark Signal	Off
Invert	OFF
Impedance	HighZ
Trigger output	Off
System Utility	
Beeper	On
Clock Source	Internal
Print Screen Format	PNG

19 Remote Control

The following ways of remote control are supported:

- **User-defined Programming**

Users can program and control the instrument by using the SCPI (Standard Commands for Programmable Instruments) commands. For details about the SCPI commands and programming, refer to *Programming Guide* of this product series.

- **PC Software**

Users usually need to use the PC software to send commands to control the instrument remotely via the USB or LAN interface, the PC software can search for instrument resources and enable command interaction.

- **Web Control**

This instrument supports Web Control. You can view the display of the real-time interface of the instrument using Web Control. Through the Web Control method, you can migrate the device control to the control terminals (e.g. PC, Mobile, iPad, and other smart terminals) to realize remote control of the instrument. Connect the instrument to the network, then input the IP address of the instrument into the address bar of the browser of your computer. When mDNS is enabled, you can also input "hostname.local" (*LXI*) to use Web Control. You have to log in before using the Web Control to modify network settings. When you first log in to the Web Control, the user name is "admin" and password is "rigol".

This instrument can be connected to the PC via the USB and LAN interface to set up communication and realize remote control through the PC.



CAUTION

Before connecting the communication cable, please turn off the instrument to avoid causing damage to the communication interfaces.

20 Troubleshooting

1. When I power on the instrument, the instrument stays black and does not display anything.

- a. Check whether the power supply has been connected correctly.
- b. Check whether the power key is really pressed.
- c. Restart the instrument after finishing the above inspections.
- d. If the problem still persists, please contact RIGOL.

2. The settings are correct but no waveform is generated.

- a. Check whether the output cable is connected to the corresponding channel output terminal tightly.
- b. Check whether the output cable has internal damage.
- c. Check whether the output cable is connected to the test instrument tightly.
- d. If the problem still persists, please contact RIGOL.

3. The USB storage device cannot be recognized.

- a. Check whether the USB storage device can work normally when connected to other instruments or PC.
- b. Make sure that the USB storage device is FAT32, NTFS, or exFAT type. The instrument doesn't support hardware USB storage device.
- c. After restarting the instrument, insert the USB storage device again to check whether it can work normally.
- d. If the USB storage device still cannot work normally, please contact RIGOL.

4. Performance verification test is failed.

- a. Check whether the generator is within calibration period (1 year).
- b. Check whether the generator has been warmed up for at least 20 minutes before the test.
- c. Check whether the generator is under the specified temperature.
- d. Check whether the test is under strong-magnetism environment.
- e. Check whether the power supplies of the generator and test system have a strong interference.
- f. Check whether the performance of the test device used meets the requirement.

- g.** Make sure that the test device used is within the calibration period.
 - h.** Check whether the test device used meets the required conditions of the manual.
 - i.** Check whether all the connections are tight.
 - j.** Check whether any cable has internal damage.
 - k.** Make sure that the operations conform to settings and processes which are required by the performance verification manual.
 - l.** Check whether the error calculation has faults.
 - m.** Correctly understand the definition of "typical value" for this product: the performance specification of this product under specified conditions.
- 5. The touch-enabled operation does not work.**
- a.** Check whether you have locked the touch screen. If yes, unlock the touch screen.
 - b.** Check whether the screen or your finger is stained with oil or sweat. If yes, please clean the screen or dry your hands.
 - c.** Check whether there is a strong magnetic field around the instrument. If the instrument is close to the strong magnetic field (e.g. a magnet), please move the instrument away from the magnet field.
 - d.** If the problem still persists, please contact RIGOL.

21 Appendix

21.1 Appendix A: Options and Accessories

Order Information	Order No.
Model	
25 MHz Bandwidth, 625 MSa/s Sample Rate	DG821 Pro
25 MHz Bandwidth, 625 MSa/s Sample Rate	DG822 Pro
50 MHz Bandwidth, 625 MSa/s Sample Rate	DG852 Pro
Standard Accessories	
Power Adaptor Conforming to the Standard of the Destination Country	— —
USB Cable	— —
One BNC Cable	CB-BNC-BNC-MM-100
Upgrade Options	
8 Mpts/CH Memory Depth Upgrade Option	DG800Pro-3RL
Two-channel Upgrade Option (for DG821 Pro only)	DG800Pro-DCH
Optional Accessories	
40 dB Attenuator (50 Ω , 1 W)	RA5040K

21.2 Appendix B: Warranty

RIGOL TECHNOLOGIES CO., LTD. (hereinafter referred to as RIGOL) warrants that the product mainframe and product accessories will be free from defects in materials and workmanship within the warranty period. If a product proves defective within the warranty period, RIGOL guarantees free replacement or repair for the defective product.

To get repair service, please contact your nearest RIGOL sales or service office.

There is no other warranty, expressed or implied, except such as is expressly set forth herein or other applicable warranty card. There is no implied warranty of merchantability or fitness for a particular purpose. Under no circumstances shall

RIGOL be liable for any consequential, indirect, ensuing, or special damages for any breach of warranty in any case.

HEADQUARTER

RIGOL TECHNOLOGIES CO., LTD.
No.8 Keling Road, New District, Suzhou,
JiangSu, P.R.China
Tel: +86-400620002
Email: info@rigol.com

EUROPE

RIGOL TECHNOLOGIES EU GmbH
Carl-Benz-Str.11
82205 Gilching
Germany
Tel: +49(0)8105-27292-0
Email: info-europe@rigol.com

NORTH AMERICA

RIGOL TECHNOLOGIES, USA INC.
10220 SW Nimbus Ave.
Suite K-7
Portland, OR 97223
Tel: +1-877-4-**RIGOL**-1
Fax: +1-877-4-**RIGOL**-1
Email: info@rigol.com

JAPAN

RIGOL JAPAN CO., LTD.
5F,3-45-6,Minamiotsuka,
Toshima-Ku,
Tokyo,170-0005,Japan
Tel: +81-3-6262-8932
Fax: +81-3-6262-8933
Email: info-japan@rigol.com

RIGOL® is the trademark of **RIGOL TECHNOLOGIES CO., LTD.** Product information in this document is subject to update without notice. For the latest information about **RIGOL's** products, applications and services, please contact local **RIGOL** channel partners or access **RIGOL** official website: www.rigol.com